



2022

KITCHENS

— Design Manual —

Faula Mobilier

66 Avenue Des Champs-Elysées

75008 Paris

Tél : 01 84 80 09 65

Adresse showroom : 555 Avenue Marguerite Perey 77127

Lieusaint FRANCE

Une marque du Group CTMG



CONTENTS

New Arrivals

- 001 New Cabinet Samples in 2022

Profile

- 010 Lacquer door
- 013 PVC door
- 020 Melamine door
- 023 UV lacquer door
- 025 Wood-framed glass door
- 029 Aluminum-framed glass door
- 034 Decorative parts
- 037 Countertop

Materials

- 040 Door panels
- 046 Back panels
- 047 Edge banding
- 049 Carcase
- 050 Glass
- 051 Countertop

Hardware Accessories

- 054 Flap door fittings
- 057 Sliding door fittings
- 058 Slides
- 059 Bar handles
- 061 Handles
- 065 Hinges
- 068 Metal legs/ Kickboards
- 070 Bartop legs
- 072 Shelf
- 074 Wine Racks
- 075 Storage system/ Permeable Mesh/ Hanging system
- 077 Open units
- 080 Others
- 081 Power supply system/Lights
- 085 Light control system/ Drawer dividers

Attachments

- 087 Drawer Divider Solutions
- 088 2022 Configuration Table of Door Panel Patterns
Kitchen Cabinets
- 091 2022 Material-Edge Banding Configuration
Table Kitchen Cabinets

Modular Cabinet

- 092 Modular Cabinet



2022 Configuration Table of Basic Hardware of Faula Mobilier Kitchen Cabinets

Basic Configuration Standard for Carcase			
Category		Configuration	
Carcase panel	Standard configuration	Material	16mm thick antibacterial particle board, both faces coated with melamine (compliant with European E1 environmental protection standard)
		Color	PWGA0017, PWGA0018, PWGA0030
	Optional configuration	Material	18mm thick antibacterial particle board, both faces coated with melamine (compliant with European E1 environmental protection standard)
		Color	PWGA0048
Edge banding of carcase		1.2mm PVC edge banding for front side (without logo), 0.5mm PVC edge banding for other sides	
Back panel of carcase		3mm thick MDF, both faces coated with melamine	
Movable shelf		same as carcase	
Edge banding of front side of movable shelf		Standard configuration: 1.2mmPVC edge banding without logo (consistent with the color of carcase panel) Optional configuration: Al-alloy edge banding (consistent with the color of carcase panel)	
Movable shelf clamp		Concealed type	
Glass shelf in the cabinet	Glass		8mm glass shelf (optional)
	Edge banding of glass shelf		Optional configuration: al-alloy edge banding (PWFL0003)
Wooden Drawer	Side Panels		same as carcase
	Edge Banding for Side Panels		Sealed with 0.5mmPVC edge banding (consistent with design and color of carcase panel)
	Bottom panel		same as carcase
Metal Drawer	Side Panels		Standard configuration: same as carcase Optional configuration: 16mm thick particle board, color: PWMG0017 (with antislip mat)
	Edge Banding for Side Panels		Sealed with 0.5mm PVC edge banding (consistent with design and color of carcase panel)
	Bottom panel		Standard configuration: same as carcase Optional configuration: 16mm thick particle board, color: PWMG0017 (with antislip mat)
Wall cabinet bracket		Domestic exposed cabinet bracket with Faula Mobilier logo	
Adjustable legs		Standard configuration: Faula Mobilier PP adjustable legs	
Kickboard		Standard configuration: 80/110mm plastic kickboard; Optional configuration: 80/110mm al-alloy kickboard	
Aluminum beam		Standard configuration for base cabinets (excluding special-shaped cabinet)	
Permeable mesh of stove cabinet		Standard configuration: plastic permeable mesh	
Sink cabinet	Stainless steel carcase/ metal panel	Standard configuration	Base of cabinet: 16mm thick waterproof particle board, both faces coated with metal foil Edge Banding: front face sealed with metal edge band, the other three are sealed with 0.5mm thick grey PVC edge bands.
		Optional configuration	Base of cabinet: 18mm thick plywood, both faces coated with honeycomb-shaped metal foil Edge Banding: front face sealed with PVC edge band, the other three are sealed with 0.5mm thick grey PVC edge bands.
	Filler + drain ring		Standard configuration
	Hole insert		Standard configuration
Dustproof accessories		Standard configuration	
Fastenings		Domestic two-in-one	
Handle		Standard configuration	
Hinge		Standard configuration: Domestic Integrated Hinge (with Faula Mobilier logo on hinge cover) Optional configuration: Imported Integrated Hinge+ Buffer	
Door buffer			
Soft closing rubber		Standard configuration	
Fastenings of sliding door		Standard configuration	

2022 Structure and Classification Table of Faula Mobilier Kitchen Door Panels

Door Panel Category	Base Material	Finish	Edge banding
Flash lacquer	MDF	Front face lacquered, the reverse face coated with white matt melamine	
High gloss lacquer	MDF	Front face lacquered, the reverse face coated with white matt melamine	
Matt lacquer	MDF	Front face lacquered, the reverse face coated with white matt melamine	
PVC foil (grade A)	MDF	Front face coated with PVC foil, the reverse face coated with white matt melamine	
PVC foil (grade B)	MDF	Front face coated with PVC foil, the reverse face coated with white matt melamine	
UV Lacquer (grade A)	MDF	UV Lacquer (single face only)	PVC edge banding
UV Lacquer (grade B)	Particle board	UV Lacquer (single face only)	PVC edge banding
Melamine	Particle board	Both faces coated with melamine	PVC edge banding





New Arrivals



Cilan

Entry Luxury Series - Lacquer

Descriptions:

Countertop: PWTE0069
 Back panel material: PWMA0215, PWMA0355
 Door panel material: PWMK2146, PWMK2014
 Door craft: YMK202, YMK005A(R300), YMK001,
 YML030 + 4mm figured glass



PWMK2014



PWMK2146



PWTE0069



PWMA0355



PWMA0215





Star Burst

Entry Luxury Series - UV Lacquer

Descriptions:

Countertop: Sintered surface BWTE0006
 Door panel color: PWMC0114, PWMC0113
 Door craft: YMC003, YML027B (Black Matt)



PWMC0113



PWMC0114



BWTE0006



PWMA0215



Galaxy Breeze

Classic Elegance Series - UV Lacquer

Descriptions:

Countertop: PWTE0049
 Door panel color: BWMA0074, PWMC0116
 Door craft: YMC032P, YMA001

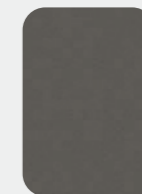

BWMA0074

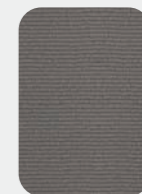

PWMC0116

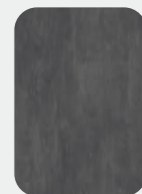

PWTE0049





Cloud Shadow

Classic Elegance Series - UV Lacquer

Descriptions:

Countertop: PWTY1026
 Door panel color: PWMC0115, PWMA0386
 Back panel color: PWMC0115, PWMA0386
 Door craft: YMC003, YMA001, YML030

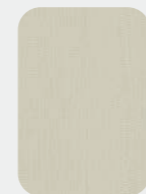

PWMC0115

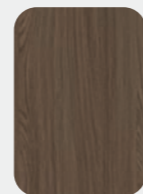

PWMA0386

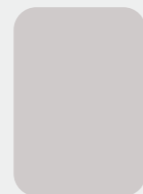

PWTY1026



Stue

Classic Elegance Series - UV Lacquer

Descriptions:

Countertop: Sintered surface BWTE0006
 Door panel color: PWMG0287, PWMG0284
 Back panel color: PWMA0355, BWMA0089
 Door craft: YMG182, YMG002, YMA001



PWMG0287



PWMG0284



BWMA0089



PWMA0355



BWTE0006





Hella

Modern Simplicity Series - Melamine

Descriptions:

Countertop: BWTE0004
 Back panel material: PWMA0382
 Door panel material: BWMG0034, BWMG0034
 Door craft: YMG153, YMA001



BWMG0034 BWMG0034 PWMA0382 BWTE0004



Dream Gaze

Modern Simplicity Series - Melamine

Descriptions:

Countertop: BWMA0047
 Door panel material: PWMA0387, PWMA0386
 Door craft: YMC003, YMA001, YML030

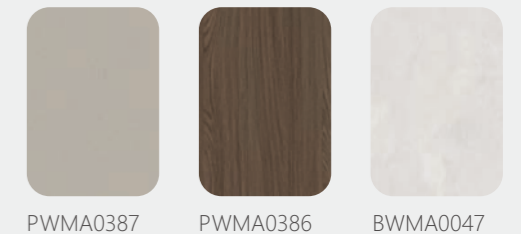

PWMA0387 PWMA0386 BWMA0047



YMK001/YMK001G



BWMK2018

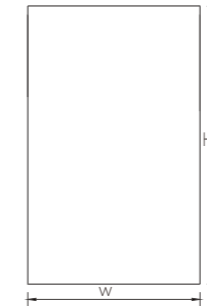

Descriptions

- Door panel: $97 \leq W \leq 600\text{mm}$, $97 \leq H \leq 1680\text{mm}$
- Drawer fronts/ Flap doors: $97 \leq W \leq 1200\text{mm}$, $97 \leq H \leq 400\text{mm}$ ($H \leq 500\text{mm}$ if for flap doors)

Notes

- Thickness: 19mm for YMK001, 22mm for YMK001G
- Base: MDF, finish: single face or both faces lacquered.
- Matched wood-framed door: YMB001, YMB011, YMB063, YMB064

Available Colors



PWMK1018



BWMK2010



BWMK2011



PWMK2014



BWMK2018



PWMK2146



PWMK3007



PWMK1053



PWMK2006

YMK002



PWMK1018

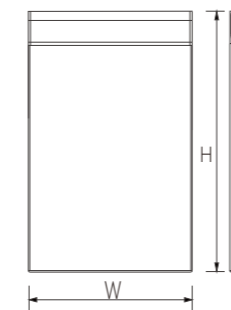

Descriptions

- Door panel: $97 \leq W \leq 600\text{mm}$, $97 \leq H \leq 1680\text{mm}$
- Drawer fronts/ Flap doors: $97 \leq W \leq 1200\text{mm}$, $97 \leq H \leq 400\text{mm}$ ($H \leq 500\text{mm}$ if for flap doors)

Notes

- Thickness: 19mm
- Base: MDF, finish: single face or both faces lacquered.
- Matched wood-framed door: YMB001, YMB011, YMB063, YMB064, and handle (PWWK0003, PWWK0008) at one side.

Available Colors



PWMK1018



BWMK2010



BWMK2011



PWMK2014



BWMK2018



PWMK2146



PWMK3007



PWMK1053



PWMK2006



YMK138



BWMK2018

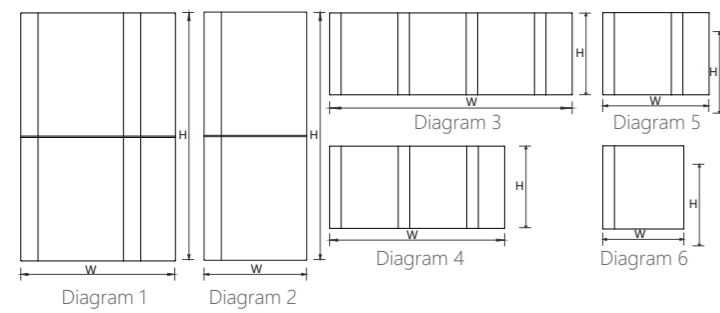

For door panels

- When $347\text{mm} \leq W \leq 600\text{mm}$, $145\text{mm} \leq H \leq 1680\text{mm}$ (When $H \geq 657\text{mm}$, with horizontal edge groove in the middle, door has 2 vertical lines as shown in the Diagram No.1.
- When $145\text{mm} \leq W < 347\text{mm}$, $145\text{mm} \leq H \leq 1680\text{mm}$ (When $H \geq 657\text{mm}$, with horizontal edge groove in the middle, door has 1 vertical line as shown in the Diagram No.2.
- When $W < 145\text{mm}$ or $H < 145\text{mm}$, door is 22mm thick flat MDF.

For drawer fronts/flap doors

- When $941\text{mm} \leq W \leq 1200\text{mm}$, $145\text{mm} \leq H \leq 400\text{mm}$ ($H \leq 500\text{mm}$ if for flap doors), door has 4 vertical lines as shown in the Diagram No.3.
- When $644\text{mm} \leq W < 941\text{mm}$, $145\text{mm} \leq H \leq 400\text{mm}$ ($H \leq 500\text{mm}$ if for flap doors), door has 3 vertical lines as shown in the Diagram No.4.
- When $347\text{mm} \leq W < 644\text{mm}$, $145\text{mm} \leq H \leq 400\text{mm}$ ($H \leq 500\text{mm}$ if for flap doors), door has 2 vertical lines as shown in the Diagram No.5.
- When $145\text{mm} \leq W < 347\text{mm}$, $145\text{mm} \leq H \leq 400\text{mm}$ ($H \leq 500\text{mm}$ if for flap doors), door has 1 vertical line as shown in the Diagram No.6.
- When $W < 145\text{mm}$ or $H < 145\text{mm}$, drawer front/flap door is 22mm thick flat MDF.

Notes

- Thickness: 22mm
- Base: MDF, finish: BWMK2018
- Not available for any wood-framed door

YMK202



PWMK2146

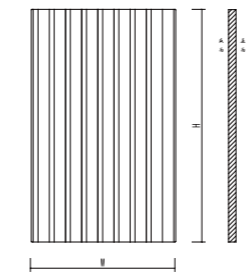

For door panels

- Width= $97+N50$ (N can be 0-10), other size than this is not available, and $97\text{mm} \leq H \leq 900\text{mm}$. When $H < 97\text{mm}$, door is 21mm thick flat panel.

For drawer fronts/flap doors

- Width= $97+N50$ (N can be 0-18), other size than this is not available, and $97\text{mm} \leq H \leq 400\text{mm}$ (drawer)/ 500mm (flap door). When $H < 97\text{mm}$, door is 21mm thick flat panel.

Notes

- Thickness: 23mm
- Base: MDF, finish: single face or both faces lacquered
- Not available for any wood-framed door

Available Colors



YMK005A



PWMK2014

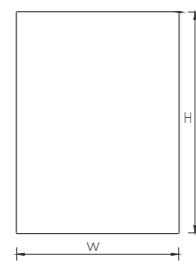

For door panels

- Flat panel in standard arc shape

Notes

- Thickness: 19mm
- Base: MDF, finish: single face or both faces lacquered

Available Colors



YMK210

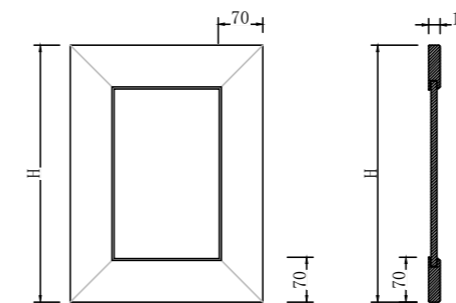

For door panels

- $170 \leq W \leq 500\text{mm}$, $196 \leq H \leq 1480\text{mm}$

For drawer fronts/flap doors

- $196 \leq W \leq 1200\text{mm}$, $170 \leq H \leq 400\text{mm}$ (height limit is 500mm)

Notes

- Base material of door panel frame is 18MM MDF , core plate is 9MM MDF, with 45 degrees corner connection;
- Without fixed handle, handle from the edge is 35mm;
- Core plate size: $H1=H-111$, $W1=W-111$, H, W is the door plate molding size.

Available Colors



YMG003



PWMG0105

Descriptions

- Door panel: W≤650mm, H≤1680mm
- Drawer fronts/ Flap doors: W≤1200mm, H≤600mm

Notes

- Thickness: 19mm
- Base: MDF, finish: PVC foil
- One side is equipped with handle PWWK0003

Available Colors



BWMG0028 BWMG0034 BWMG0035 BWMG0044 BWMG0046 BWMG0047 PWMG0105 PWMG0284 PWMG0287

YMG005

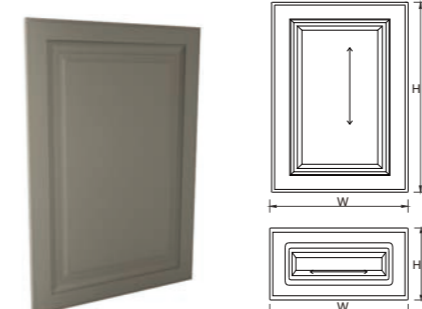

BWMG0034

For door panels

- When $W \geq 145$ mm, door profile is same as the shown diagram(When $W \geq 210$, the door has 4 right angles. When $145 \leq W < 210$, the door has 4 round angles)
- When $W < 145$ mm or $H < 145$ mm, door is flat MDF, outer edges routed.

For drawer fronts/flap doors

- When $W \geq 145$ mm, $H \geq 145$ mm, drawer front/flap door is same as the shown diagram(When $H \geq 210$, the door has 4 right angles. When $145 \leq H < 210$, the door has 4 round angles).
- When $W < 145$ mm or $H < 145$ mm, drawer front/flap door is flat MDF, outer edges routed.

Notes

- Thickness: 19mm
- Base: MDF, finish: PVC foil
- Matched wood-framed door: YMB001, YMB003, YMB009, YMB011, YMB035

Available Colors



BWMG0028 BWMG0034 BWMG0035 BWMG0044 BWMG0046 BWMG0047 PWMG0105 PWMG0284 PWMG0287

YMG004



BWMG0028

For door panels

- When $W/H \geq 145$ mm, door profile is same as the shown diagram(When $W \geq 210$, the door has 4 right angles. When $145 \leq W < 210$, the door has 4 round angles. When $W \geq 275$ mm, door has $\Phi 4$ mm semicircle edge groove).
- When $W < 145$ mm or $H < 145$ mm, door is flat MDF, outer edges routed.

For drawer fronts/flap doors

- When $W \geq 145$ mm, $H \geq 145$ mm, drawer front/flap door is same as the shown diagram(When $H \geq 210$, the door has 4 right angles. When $145 \leq H < 210$, the door has 4 round angles. When $W \geq 275$ mm, door has $\Phi 4$ mm semicircle edge groove).
- When $W < 145$ mm or $H < 145$ mm, drawer front/flap door is flat MDF, outer edges routed.

Notes

- Thickness: 19mm
- Base: MDF, finish: PVC foil
- Matched wood-framed door: YMB001, YMB003, YMB009, YMB011, YMB035

Available Colors



BWMG0028 BWMG0034 BWMG0035 BWMG0044 BWMG0046 BWMG0047 PWMG0105 PWMG0284 PWMG0287

YMG019

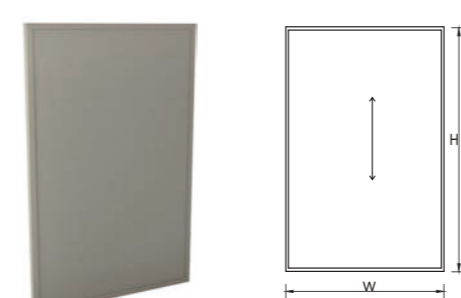

BWMG0034

For door panels

- When $97 \leq W \leq 650$ and $98 \leq H \leq 1680$, door profile is same as the shown diagram.
- When $20 \leq W < 97$ and $97 \leq H \leq 2400$, door panel is 22mm thick flat MDF, outer edges rounded.

For drawer fronts/flap doors

- When $97 \leq H \leq 600$ and $97 \leq W \leq 1200$, door profile is same as the shown diagram.
- When $20 \leq H < 97$ and $97 \leq W < 2400$, door panel is 22mm thick flat MDF, outer edges rounded.

Notes

- Thickness: 21mm
- Base: MDF, finish: PVC foil
- Matched wood-framed door: YMB001, YMB003, YMB011

Available Colors



BWMG0028 BWMG0034 BWMG0035 BWMG0044 BWMG0046 BWMG0047 PWMG0105 PWMG0284 PWMG0287



YMG040

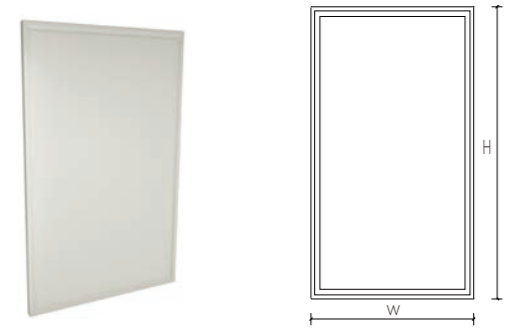

BWMG0028

For drawer fronts/flap doors

-When $147 \leq W \leq 650\text{mm}$ and $147 \leq H \leq 1680\text{mm}$, door panel/drawer front/flap door is same as the shown diagram.
 - $W < 147\text{mm}$ or $H < 147\text{mm}$, door panel/drawer front/flap door is 22mm flat MDF, outer edges rounded.

Notes

-Thickness: 22mm
 -Base: MDF, finish: PVC foil
 -Matched wood-framed door: YMB001, YMB003, YMB005, YMB009

Available Colors



YMG085

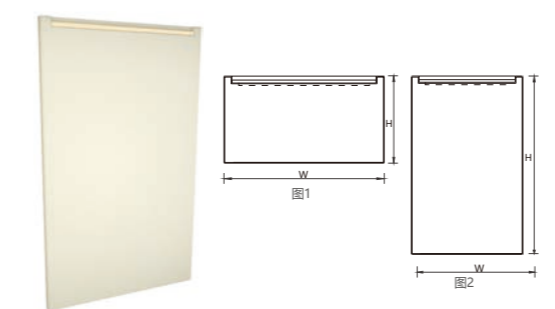

BWMG0028

For door panels/drawer fronts/flap doors

-When $W \geq 195\text{mm}$ and $H \geq 145\text{mm}$, door panel/drawer front/flap door is same as the shown diagram. Equipped with handle PWWK0011.
 -When $W < 195\text{mm}$ or $H < 145\text{mm}$, door panel/drawer front/flap door is 22mm thick flat MDF without handle.

Notes

-Thickness: 22mm
 -Base: MDF, finish: PVC foil
 -Matched wood-framed door: YMB001, YMB003

Available Colors



YMG059

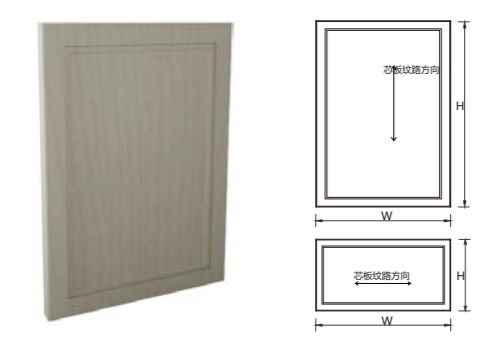

PWMG0105

For door panels/drawer fronts/flap doors

-Door is 18mm+5mm shaped MDF.
 -Core is 5mm thick panel, with shaped edges, framed with 18mm thick panel.
 -When $W \geq 130\text{mm}$ and $H \geq 130\text{mm}$, door panel/drawer front/flap door is same as the shown diagram.
 -When $W < 130\text{mm}$ or $H < 130\text{mm}$, door panel/drawer front/flap door is 22mm thick flat MDF.
 The shape of door frame is same as the door profile.

Notes

-Thickness: 23mm
 -Base: MDF, finish: PVC foil
 -Matched wood-framed door: YMB001, YMB003

Available Colors



YMG099



BWMG0035

For door panels/drawer fronts/flap doors

-When $W \geq 237\text{mm}$ and $H \geq 145\text{mm}$, door panel/drawer front/flap door is same as the shown diagram. With imbedded decorative metal strip on the surface and handle BWWL0063.
 -When $W < 237\text{mm}$ or $H < 145\text{mm}$, door panel/drawer front/flap door is 22mm thick flat MDF.

Notes

-Thickness: 22mm
 -Base: MDF, finish: PVC foil
 -Matched wood-framed door: YMB001, YMB003

Available Colors



YMG099A

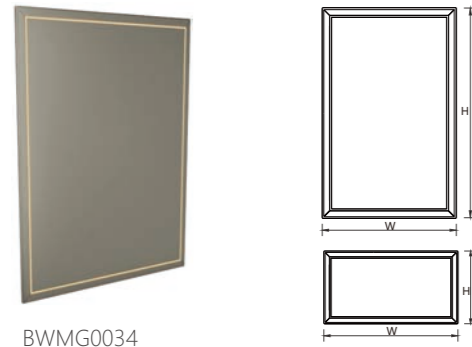

BWMG0034

For door panels/drawer fronts/flap doors

- When $W \geq 237\text{mm}$ and $H \geq 145\text{mm}$, door panel/drawer front/flap door is same as the shown diagram. With imbedded metal decorative strip on the surface.
- When $W < 237\text{mm}$ or $H < 145\text{mm}$, door panel/drawer front/flap door is 22mm thick flat MDF.

Notes

- Thickness: 22mm
- Base: MDF, finish: PVC foil
- Matched wood-framed door: YMB001, YMB003

Available Colors



YMG130B

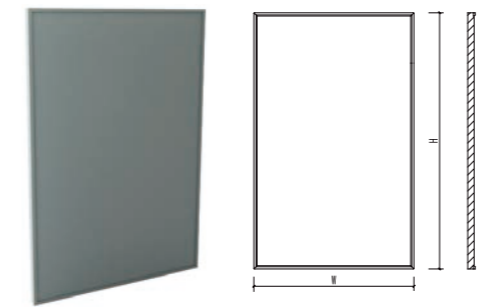

BWMG0046

For door panels/drawer fronts/flap doors

- When $W \geq 97\text{mm}$ and $H \geq 97\text{mm}$, door panel/drawer front/flap door is same as the shown diagram, without handle.
- When $W < 97\text{mm}$ or $H < 97\text{mm}$, door panel/drawer front/flap door is 22mm thick flat panel, outer edges rounded.

Notes

- Thickness: 22mm
- Base: MDF, finish: PVC foil
- Matched wood-framed door: YMB001, YMB003, YMB005, YMB008, YMB011

Available Colors



YMG130A

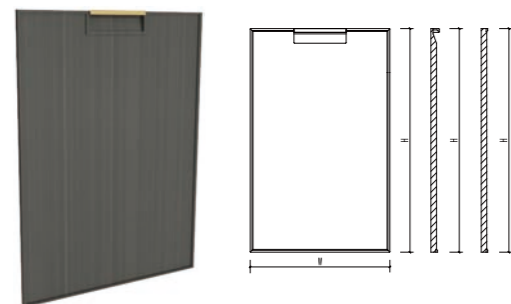

BWMG0044

For door panels

- Equipped with handle BWWL0064, installed at the top/bottom/left/right of the door.
- When handle is at the top/bottom of the door, $217\text{mm} \leq W \leq 650\text{mm}$ and $97\text{mm} \leq H \leq 1680\text{mm}$.
- When handle is at the left/right of the door, $97\text{mm} \leq W \leq 650\text{mm}$ and $217\text{mm} \leq H \leq 1680\text{mm}$.
- When $97\text{mm} \leq W < 217\text{mm}$ and $97\text{mm} \leq H < 217\text{mm}$, door is same as YMG130B, without handle BWWL0064.
- When $W < 97\text{mm}$ or $H < 97\text{mm}$, door is 22mm thick flat panel, outer edges routed.

For drawer fronts/flap doors

- Equipped with handle BWWL0064, installed at the upper center or lower center of the door.
- When $217\text{mm} \leq W \leq 1200\text{mm}$ and $97\text{mm} \leq H \leq 400\text{mm}$ (drawer)/ 500mm (flap door), drawer front/flap door is same as the shown diagram, with handle BWWL0064.
- When $97\text{mm} \leq W < 217\text{mm}$ and $97\text{mm} \leq H \leq 400\text{mm}$ (drawer)/ 500mm (flap door), drawer front/flap door is same as YMG130B, without handle BWWL0064.
- When $W < 97\text{mm}$ or $H < 97\text{mm}$, door is 22mm thick flat panel, outer edges rounded.

Notes

- Thickness: 22mm
- Base: MDF, finish: PVC foil
- Matched wood-framed door: YMB001, YMB003, YMB005, YMB008, YMB011

Available Colors



YMG131

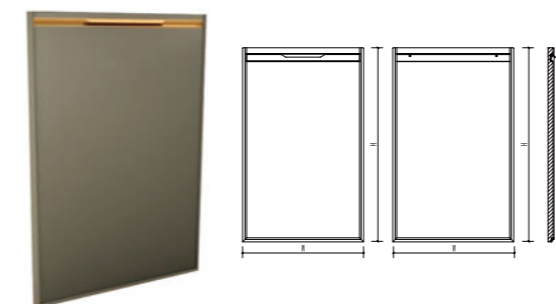

BWMG0047

For door panels

- Equipped with handle BWWK0012A/B, can be installed at the top/bottom of the door only.
- When $520\text{mm} < W \leq 650\text{mm}$ and $117\text{mm} \leq H \leq 1680\text{mm}$, door is equipped with handle BWWK0012B.
- When $227\text{mm} \leq W \leq 520\text{mm}$ and $117\text{mm} \leq H \leq 1680\text{mm}$, door is equipped with handle BWWK0012A.
- When $W < 227\text{mm}$ or $H < 117\text{mm}$, door is 22mm thick flat panel, without handle BWWK0012A/B/C.
- Not available for flap doors.

For drawer fronts

- Equipped with handle BWWK0012A/B/C, can be installed at the top or the bottom of the door only.
- When $920\text{mm} < W \leq 1200\text{mm}$ and $117\text{mm} \leq H \leq 400\text{mm}$, drawer front is equipped with handle BWWK0012C.
- When $520\text{mm} < W \leq 920\text{mm}$ and $117\text{mm} \leq H \leq 400\text{mm}$, drawer front is equipped with handle BWWK0012B.
- When $227\text{mm} \leq W \leq 520\text{mm}$ and $117\text{mm} \leq H \leq 400\text{mm}$, drawer front is equipped with handle BWWK0012A.
- When $W < 227\text{mm}$ or $H < 117\text{mm}$, drawer front is 22mm thick flat panel, without handle BWWK0012A/B/C.
- Not available for flap doors.

Notes

- Thickness: 22mm
- Base: MDF, finish: PVC foil
- Matched wood-framed door: YMB001, YMB003, YMB005, YMB011

Available Colors



YMG153(D22)

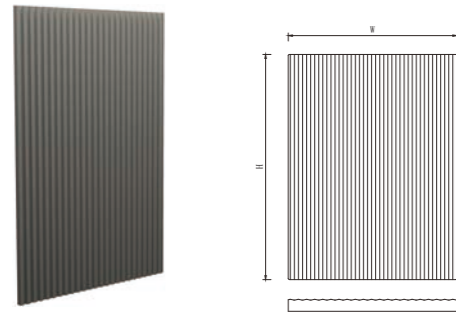

PWMG0287

For door panels

-When $97\text{mm} \leq W \leq 600\text{mm}$, $97\text{mm} \leq H \leq 1200\text{mm}$, door is same as the shown diagram.
When $W < 97\text{mm}$ or $H < 97\text{mm}$, door is 22mm thick flat MDF.

For drawer fronts/flap doors

-When $97\text{mm} \leq W \leq 1000\text{mm}$, $97\text{mm} \leq H \leq 400\text{mm}$ (drawer)/500mm (flap door), door is same as the shown diagram.
When $W < 97\text{mm}$ or $H < 97\text{mm}$, door is 22mm thick flat MDF.

Notes

-When $97\text{mm} \leq W \leq 1000\text{mm}$, $97\text{mm} \leq H \leq 400\text{mm}$ (drawer)/500mm (flap door), door is same as the shown diagram.
When $W < 97\text{mm}$ or $H < 97\text{mm}$, door is 22mm thick flat MDF.

Available Colors



BWMG0028 BWMG0034 BWMG0035 BWMG0044 BWMG0046 BWMG0047 PWMG0105 PWMG0284 PWMG0287

YMG182

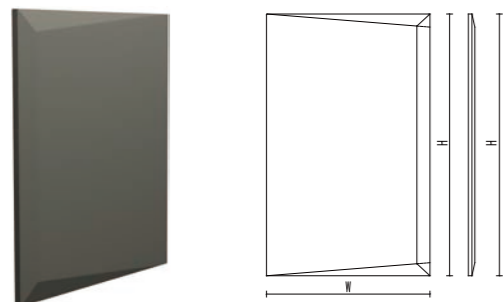

PWMG0287

Descriptions

-When $97\text{mm} \leq W \leq 650\text{mm}$, $97\text{mm} \leq H \leq 1680\text{mm}$, door is same as the shown diagram.
When $W < 97\text{mm}$ or $H < 97\text{mm}$, door is 18mm thick flat panel.
-Not available for drawer fronts/flap doors.
-Hinge is installed at the front face.

Notes

-Thickness: 18mm
-Base: MDF
-Not available for any wood-framed door.

Available Colors



BWMG0028 BWMG0034 BWMG0035 BWMG0044 BWMG0046 BWMG0047 PWMG0105 PWMG0284 PWMG0287

YMG002

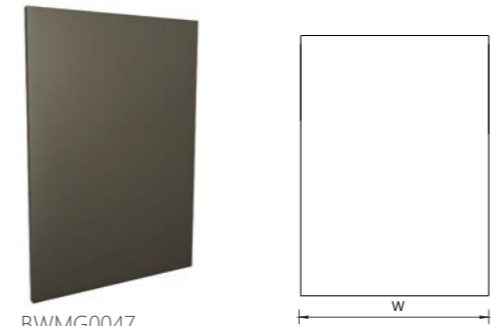

BWMG0047

Available Colors



BWMG0028 BWMG0034 BWMG0035 BWMG0044 BWMG0046 BWMG0047 PWMG0105 PWMG0284 PWMG0287

For door panels

$97 \leq W \leq 650$ and $97 \leq H \leq 1680$

For drawer fronts/flap doors

$97 \leq W \leq 1200$ and $97 \leq H \leq 600$

Notes

-Thickness: 19mm
-Base: MDF, finish: PVC foil
-18mm thick flat panel. Size of round angle: $20 \leq W < 97$ and $97 \leq H \leq 1680$
-Matched wood-framed door: YMB001, YMB003, YMB011, YMB063, YMB064

YMA001P

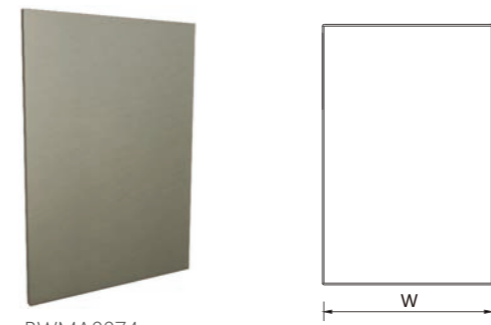

BWMA0074

Available Colors



BWMA0013 BWFP0027 BWMA0025 BWFP0045 BWMA0046 BWFP0067 BWMA0047 BWFP0068 BWMA0052 BWFP0076 BWMA0056 BWFP0073 BWMA0070 PWFP0417 BWMA0071 BWFP0066 BWMA0074 BWFP0095 BWMA0083 BWFP0112 BWMA0084 BWFP0114 BWMA0085 BWFP0110 BWMA0086 BWFP0111 BWMA0087 PWFP0034 BWMA0104 BWFP0113 BWMA0105 BWFP0133 PWMA0128 PWFP0388 PWMA0157 PWFP0449 PWMA0215 PWMA0381 PWFP0824 PWMA0386 PWFP0828 PWMA0387 PWFP0829 PWMA0196 PWFP0499

Notes

-Thickness: 18mm
-Base: particle board, finish: melamine
-Matched wood-framed door: YMB006, YMB008, YMB011, YMB063, YMB064
-Sealed with PVC edge banding.



YMA009P



BWMA0084

Notes

- Thickness: 18mm
- Base: particle board, finish: melamine
- Matched wood-framed door: YMB006, YMB008, YMB011
- Al-alloy handle (PWWK0003, PWWK0008) at one side, the other sides sealed with PVC edge banding.

Available Colors

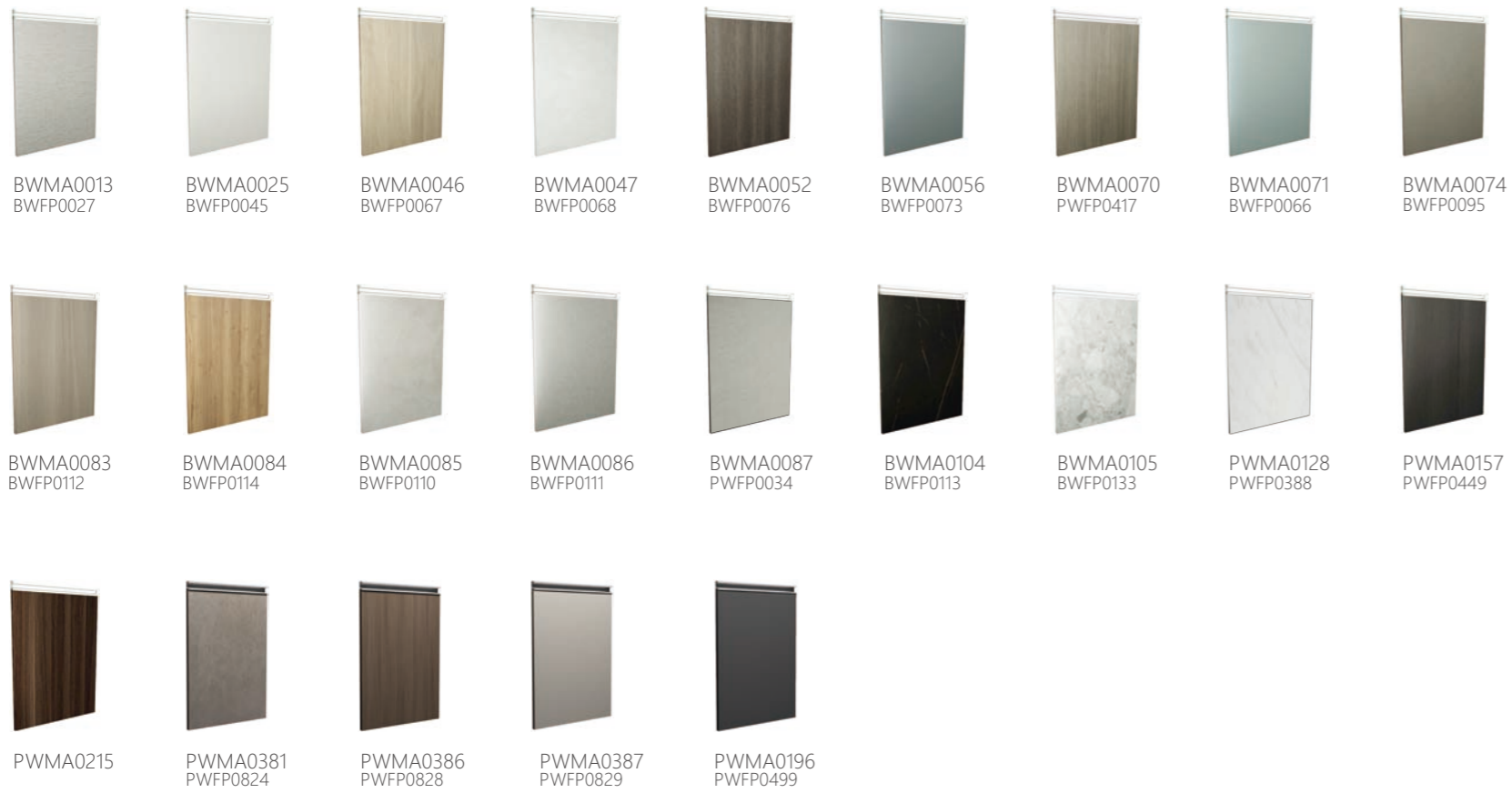

YMA085P

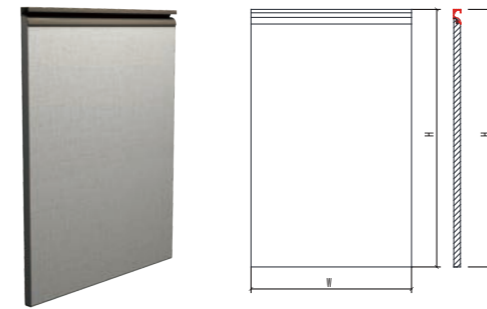

BWMA0013

Descriptions

- Equipped with handle PWWK0118, can be installed at the top/bottom/left/right of the door.
- Size limits: 97mm≤W≤650mm, 97mm≤H≤1680mm
- When W < 97mm or H < 97mm, door is 18mm thick flat panel, not available for this type of door profile.

Notes

- Thickness: 18mm
- Base: particle board, finish: melamine
- Available for YMB006, YMB008, YMB011, YMB063, YMB064, door frame is 80mm.

Available Colors

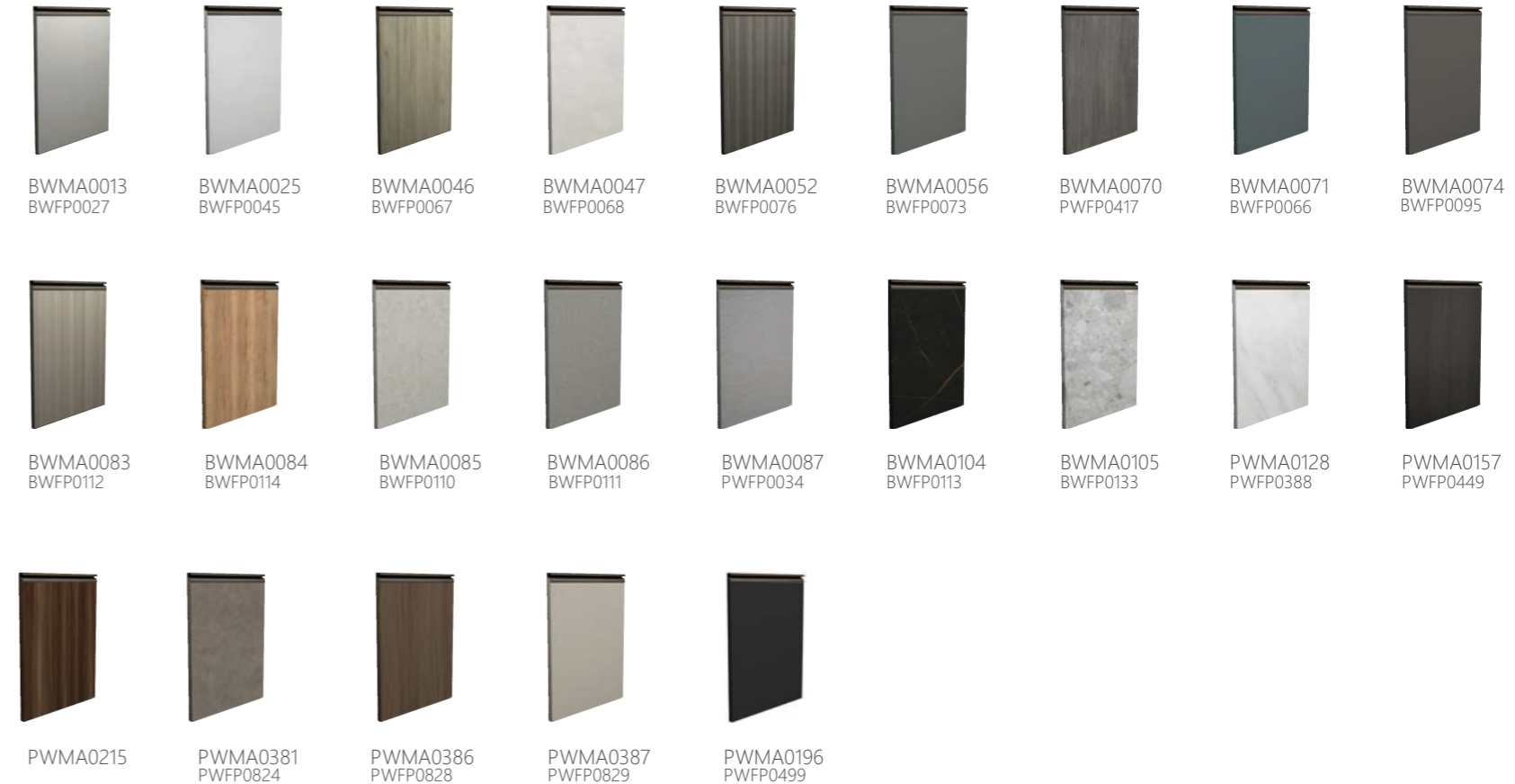

YMC003P

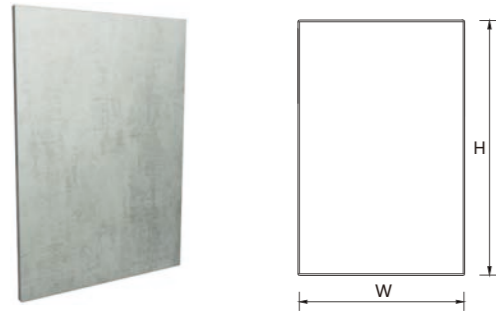

PWMC0019

Notes

- Thickness: 19mm
- Base: particle board, finish: UV lacquer
- Matched wood-framed door: YMB006, YMB011, YMB008, YMB063, YMB064
- Sealed with PVC edge banding.

Available Colors

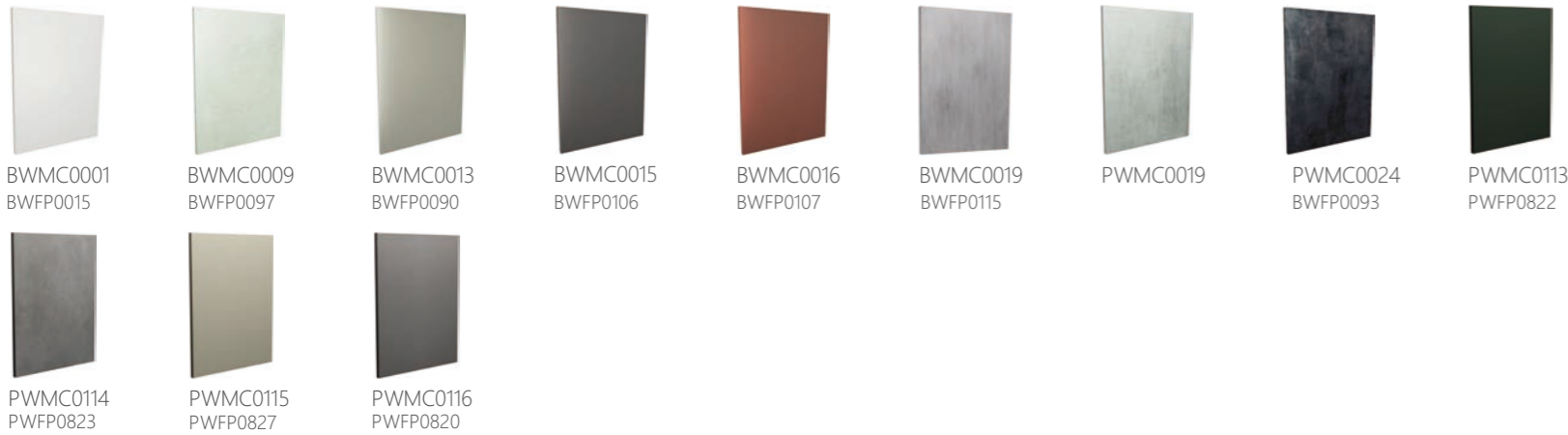

UV LACQUER

YMC032P

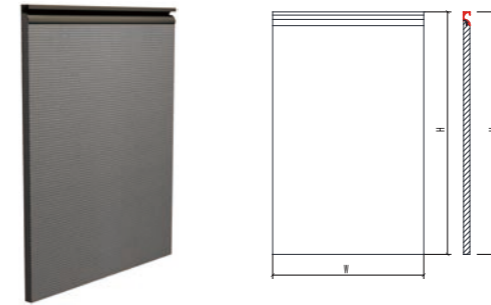

PWMC0116

Descriptions

- Equipped with handle PWWK0118, can be installed at the top/bottom/left/right of the door.
- Size limits: 97mm≤W≤650mm, 97mm≤H≤1680mm
- When W < 97mm or H < 97mm, door is 18.5 mm thick flat panel, not available for this type of door profile.

Notes

- Thickness: 18mm
- Base: particle board, finish: melamine
- Available for YMB006, YMB008, YMB011, YMB063, YMB064, door frame is 80mm.

Available Colors



YMC010P

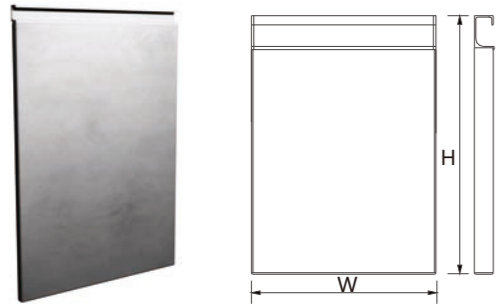

BWMC0019

Descriptions

- Door panel: W≤650mm, H≤1680mm
- Drawer fronts/ Flap doors: W≤1200mm, H≤600mm

Notes

- Thickness: 19mm
- Base: particle board, finish: UV lacquer
- Matched wood-framed door: YMB006, YMB011, YMB008
- Al-alloy handle PWWK0003 at one side, the other sides sealed with PVC edge banding.

Available Colors



WOOD FRAMED GLASS DOORS

YMB001

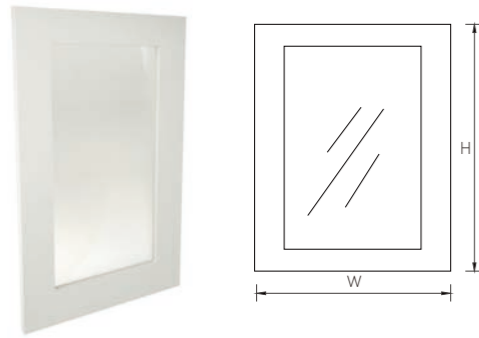

Descriptions

- Glass insert is sealed with plastic trim
- Optional finish: PVC foil, paint.

Notes

- Thickness/Base/Finish is subject to door panel.

YMB006

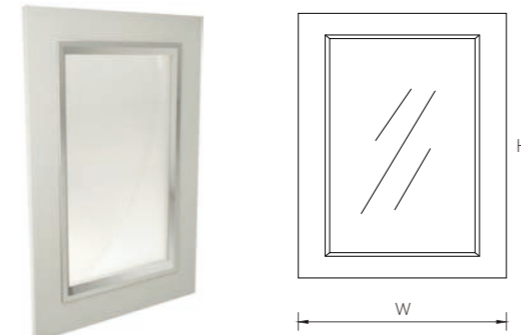

Descriptions

- Single-sided aluminum alloy and single-sided plastic built-in glass door, Suitable for melamine.

Notes

- Thickness:18/19/21mm
- Base materials, finishes are subject to door panels.

YMB002

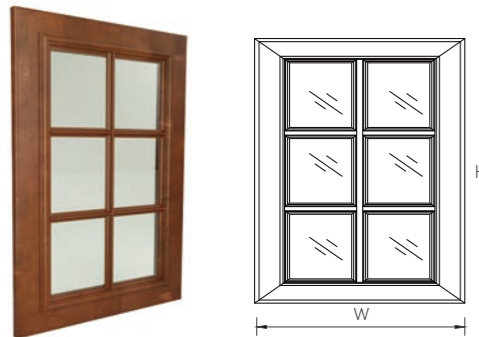

Descriptions

- Wood framed glass door.
- Size: $296 \leq W \leq 650\text{mm}$, $447 \leq H \leq 1680\text{mm}$

Notes

- Thickness/Base/Finish is subject to door panel.
- Two horizontal bars when $447 \leq H < 600$. Three horizontal bars when $600 \leq H \leq 1200$. Four horizontal bars when $1200 < H \leq 1680$.

YMB008

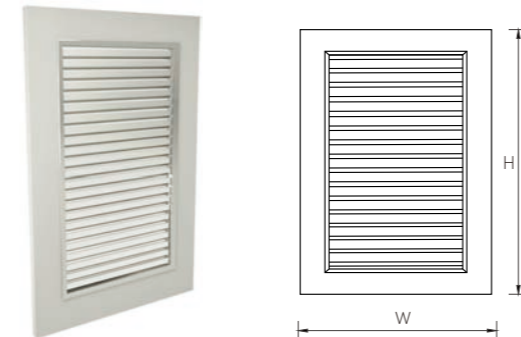

Descriptions

- Not suitable for surface-grooved door styles.

Notes

- Thickness:18/19/21mm
- Base materials, finishes are subject to door panels.

YMB003

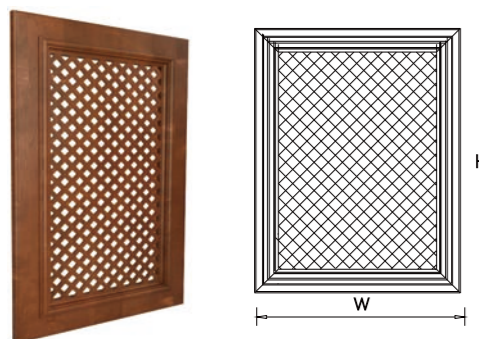

Descriptions

- When the door is PVC-coated, the frame is PVC-coated and the core is MDF as shown in the diagram.

Notes

- Thickness, base materials, finishes are subject to door panels.

YMB009

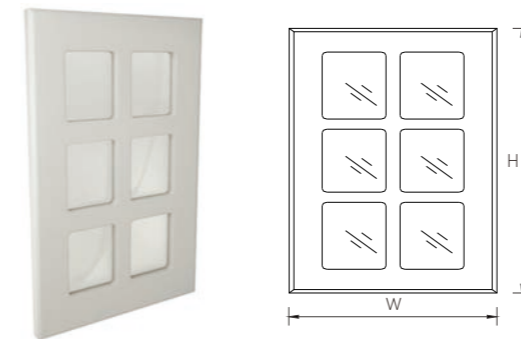

Descriptions

- Two horizontal bars when $447 \leq H < 600$. Three horizontal bars when $600 \leq H \leq 1200$. Four horizontal bars when $1200 < H \leq 1680$.

Notes

- Door thickness: 19mm
- Base: MDF, Finish: PVC foil



YMB011

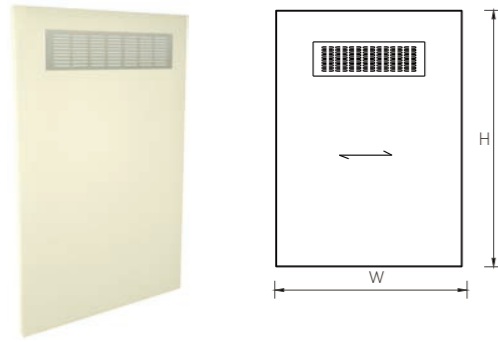

Descriptions

- Door thickness:18~20mm
- Available finish: lacquer/PVC foil/ melamine/UV lacquer

Notes

- Thickness, base materials, finishes are subject to door panels.

YMB063 (Double-sided permeable mesh type)

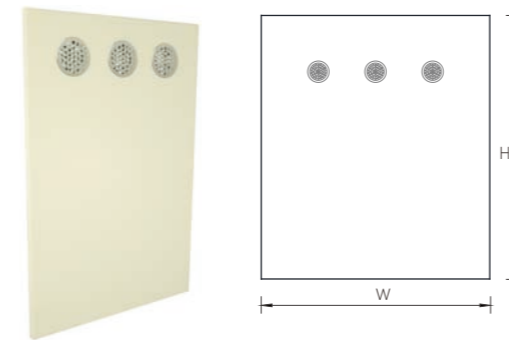

Descriptions

- Available finish: lacquer/PVC foil/ melamine/UV lacquer. Door thickness:18~22mm
- Matched door size: $W \geq 297\text{mm}$, $H \geq 197\text{mm}$
- Equipped with 3 sets of $\varnothing 42\text{mm}$ stainless steel round permeable mesh.

Notes

- Thickness, base materials, finishes are subject to door panels.

YMB014

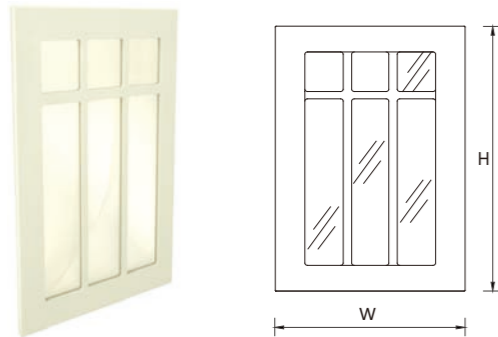

Descriptions

- Available finish: PVC foil. Size: $W \geq 398\text{mm}$, $H \geq 397\text{mm}$

Notes

- Door thickness: 19mm
- Base materials, finishes are subject to door panels.

YMB064 (Double-sided permeable mesh type)

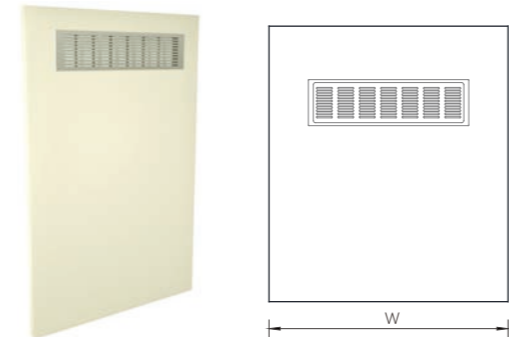

Descriptions

- Available finish: lacquer/PVC foil/ melamine/UV lacquer. Door thickness:18~22mm
- When $197 \leq W < 397\text{mm}$, $H \geq 397\text{mm}$, permeable mesh is vertically mounted.
- When $W \geq 397\text{mm}$, $H \geq 197\text{mm}$, permeable mesh is horizontally mounted.
- Equipped with permeable meshes on both faces.

Notes

- Thickness, base materials, finishes are subject to door panels.

YMB035

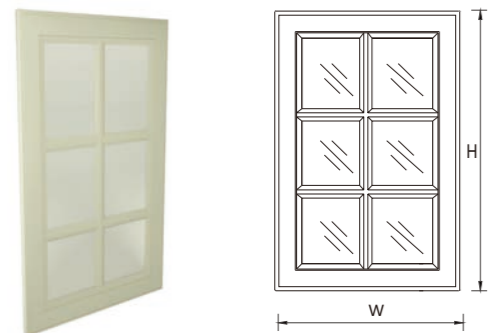

Descriptions

- Available for YMG005, YMG004. Size: $296 \leq W \leq 650\text{mm}$ and $447 \leq H \leq 1680\text{mm}$
- Two horizontal bars when $447 \leq H < 600$. Three horizontal bars when $600 \leq H \leq 1200$. Four horizontal bars when $1200 < H \leq 1680$.

Notes

- Thickness, base materials, finishes are subject to door panels.



ALUMINUM-FRAMED GLASS DOOR

YML003C

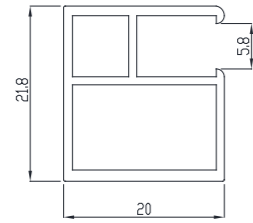

Descriptions

-Only for hinged door.

Notes

-Aluminum frame color: matt black
-Insert: glass, acrylic

YML028

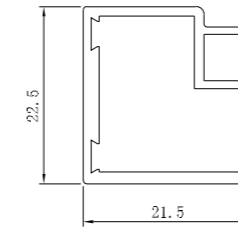

Descriptions

-Only for hinged door.

Notes

-Aluminum frame color: matt black
-Insert: glass, acrylic

YML027A

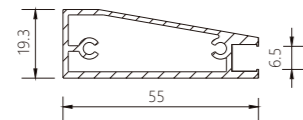

Descriptions

-Only for hinged door.

Notes

-Aluminum frame color: matt black
-Insert: glass, acrylic

YML030

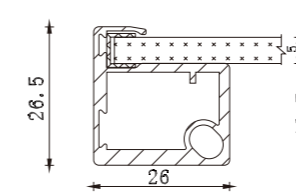

Descriptions

-Only for hinged door.
-Equipped with handle and air hinge.
-Size: 257mm≤W≤600mm, 297mm≤H≤2400mm

Notes

-Aluminum frame color: matt black
-Insert: PWMB0098, PWMB0125
-Aluminum beam: only for 18mm/19mm carcase. Width: W=carcase width -36/38mm

YML027B

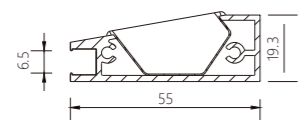

Descriptions

-Only for hinged door.

Notes

-Aluminum frame color: matt black
-Insert: glass, acrylic

YML030A

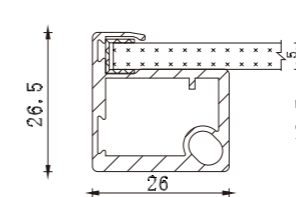

Descriptions

-Only for hinged door.
-Equipped with handle and air hinge.
-Size: 257mm≤W≤600mm, 297mm≤H≤2400mm

Notes

-Aluminum frame color: red champagne
-Insert: glass
-Aluminum beam: only for 18mm/19mm carcase. Width: W=carcase width -36/38mm



ALUMINUM-FRAMED GLASS DOOR

YML037

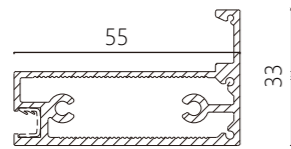

Descriptions

- Only for hinged door.
- Equipped with handle and vertical frame at the opening side
- Size: 257mm≤W≤600mm, 297mm≤H≤2400mm

Notes

- Aluminum frame color: matt black
- Insert: glass, acrylic

YML040B

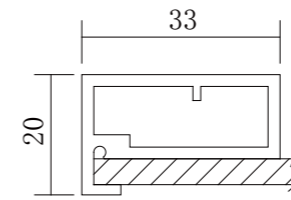
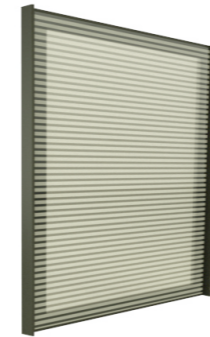

Descriptions

- Equipped with handle and gray bearing type hinge.
- Door panel size: 247mm≤W≤600mm, 347mm≤H≤2400mm

Notes

- Aluminum frame color: gray
- Insert: 4mm thick black glass, 4mm thick black glass in striped pattern 4mm thickness
- Only for hinged door.
- Carcase thickness: 18-19mm

YML038

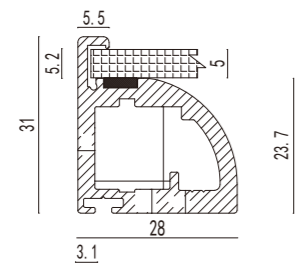

Descriptions

- Equipped with handle and air hinge.
- Size: 257mm≤W≤600mm, 297mm≤H≤2400mm

Notes

- Aluminum frame color: brass brushed
- Insert: PWMB0002, PWMB012, PWMB0127, PWMB0128, PWMB0129
- Only for hinged door.
- Aluminum beam: only for 18mm/19mm carcass. Width: W=carcass width -36/38mm

YML060

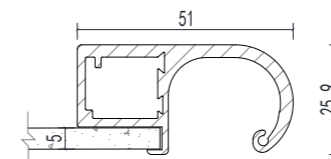

Descriptions

- Door frame is equipped with handle and matching narrow hinge.
- Size: When handle at the left/right side: 157mm≤W≤650mm, 297mm≤H≤2340mm. When handle at the top/bottom: 157mm≤W≤650mm, 327mm≤H≤2340mm
- Not available for drawers/ flap doors

Notes

- Aluminum frame color: coffee copper
- Insert: glass

YML040A

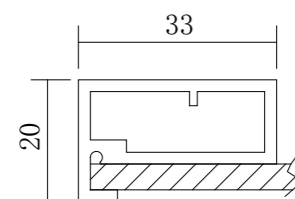

Descriptions

- Equipped with handle and brass-brushed bearing type hinge.
- Door panel size: 247mm≤W≤600mm, 347mm≤H≤2400mm

Notes

- Aluminum frame color: brass brushed
- Insert: 4mm thick black glass, 4mm thick black glass in striped pattern 4mm thickness
- Only for hinged door.
- Carcass thickness: 18-19mm

YML061A

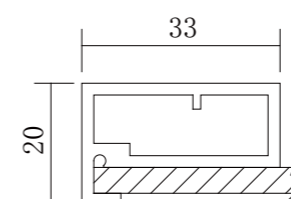

Descriptions

- Door frame is equipped with surface-mounted handle and air hinge.
- Matching 18-19mm thick carcass panel.
- Size: 197mm≤W≤650mm, 297mm≤H≤2340mm
- Not available for drawers/ flap doors

Notes

- Aluminum frame color: gray
- Insert: glass



YML061B

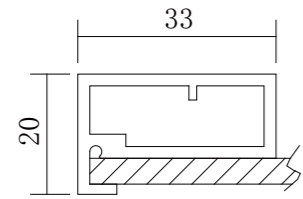

Descriptions

- Door frame is equipped with surface-mounted handle and air hinge.
- Matching 18-19mm thick carcase panel.
- Size: 197mm≤W≤650mm, 297mm≤H≤2340mm
- Not available for drawers/ flap doors

Notes

- Aluminum frame color: coffee copper
- Insert: glass

YML062

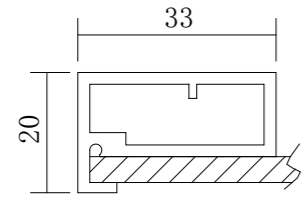

Descriptions

- Aluminum framed door panel for sliding door. Matching PWWT0050A/B sliding door fitting.
- Matching 18-19mm thick carcase panel.
- Size: 580mm≤W≤1000mm, 297mm≤H≤2226mm
- Not available for hinged door, drawer, flap door. Without handle.

Notes







- Aluminum frame color: brass brushed
- Insert: glass

DECORATIVE PARTS

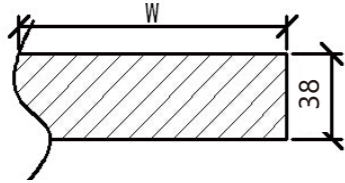
Name	Code	Diagram	Material	Notes
Crown Mouldings	YSL026		Base: MDF Finish: PVC/PP foil coated	-Length = 2200mm/PC -Installed at the top of wall cabinets, high cabinets
	YSL084		Base: Solid wood Finish: paint (for the entire crown moulding)	-Length = 2200mm/PC -Installed at the top of wall cabinets, high cabinets
Light Cornice	YSR008		Base: MDF Finish: PVC/PP foil/ lacquer	-Length = 2200mm/PC
Shelves	YSG008		Base material and finish is subject to door panel.	Flat panel straight edge
	YSG010		Base material and finish is subject to door panel.	50 thick flat panel straight edge
	YSG013		Base material and finish is subject to door panel.	38 thick flat panel straight edge

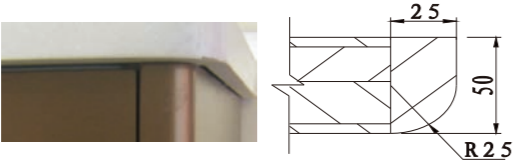



DECORATIVE PARTS

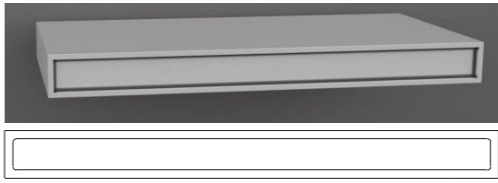
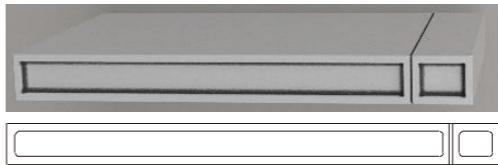
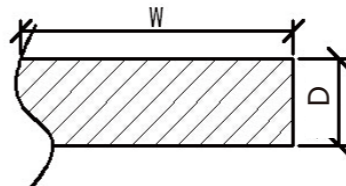

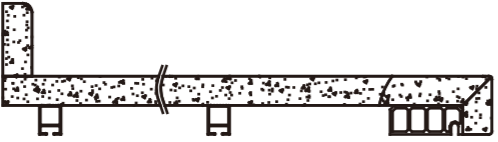
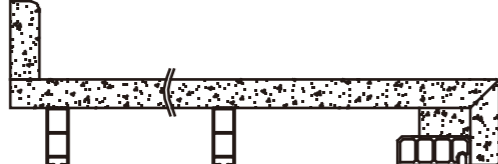
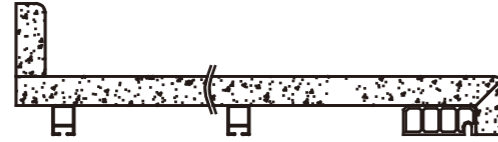
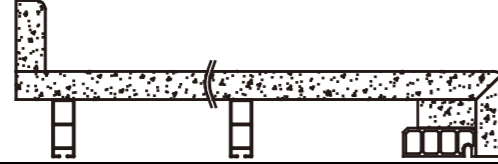
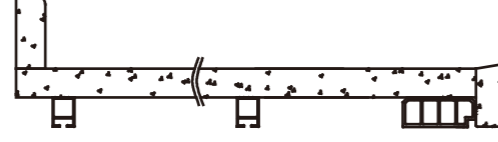

Name	Code	Diagram	Material	Notes
Decorative Shelves	YSB002		Base: MDF Finish: lacquer	38mm thick flat panel straight edge, lacquered panel
	YSB011		Base: MDF Finish: PVC foil	Finish: PVC foil (excluding high gloss PVC)
	YSB013		Base: MDF Finish: PVC foil	Finish: PVC foil
	YSB015		Base: subject to door panel. Finish: Melamine/ lacquer/ PVC foil	50 thick decorative shelves, available for Melamine/ lacquer/ PVC foil
	YSB018		Base material and finish is subject to door panel.	Flat panel straight edge
	YSB019		Base: MDF Finish: PVC foil	Finish: PVC foil

Name	Code	Diagram	Material	Notes
Decorative Shelves	YSB066		Base: MDF Finish: PVC foil	Both faces coated with PVC foil
	YSB201		Base: MDF Finish: PVC foil	W=60mm, coated with PVC foil
	YSB209		Base: MDF Finish: PVC foil	W=50mm, coated with PVC foil
Top Panels	YSD008		Base material and finish is subject to door panel.	Flat panel straight edge

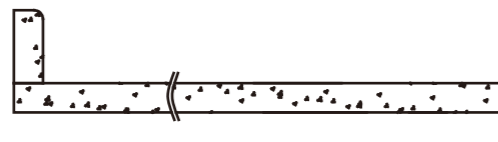
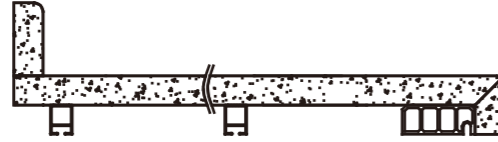
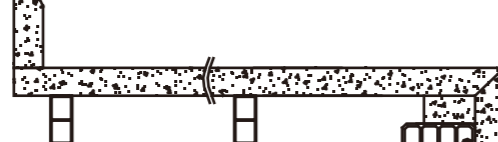

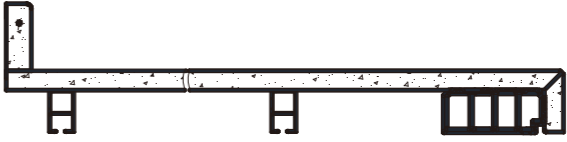
QUARTZ STONE/ SINTERED SURFACE

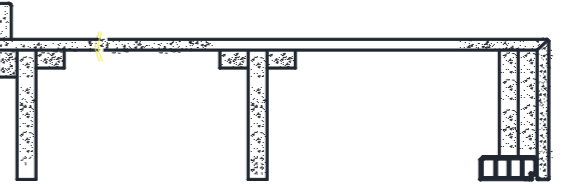
Material	Code	Name	Diagram	Descriptions	Notes
Quartz stone	YTS001A	Straight edge 20		Finish: quartz stone Thickness: 20	use the quartz stone filler strip
	YTS001B	Straight edge 40		Finish: quartz stone Thickness: 40	
	YTS001C	Straight edge 60		Finish: quartz stone Thickness: 60	
	YTS002B	Top round edge 40		Finish: quartz stone Thickness: 40	When countertop thickness is 40/60mm, use Al-alloy filler strip. The standard thickness of Al-alloy filler strip is 20mm or 40mm.
	YTS002C	Top round edge 60		Finish: quartz stone Thickness: 60	
	YTS003B	Bevel edge antispill 40		Finish: quartz stone Thickness: 40	
	YTS003C	Bevel edge antispill 60		Finish: quartz stone Thickness: 60	
	YTS005A	Single board bevel edge		Finish: quartz stone Thickness: 20	
	YTS005B	Bevel edge 40		Finish: quartz stone Thickness: 40	When countertop thickness is 40/60mm, use Al-alloy filler strip. The standard thickness of Al-alloy filler strip is 20mm or 40mm.
	YTS005C	Bevel edge 60		Finish: quartz stone Thickness: 60	

Material	Code	Name	Diagram	Descriptions	Notes
Sintered surface	YTE001A	Bevel edge 37		Finish: sintered surface Thickness: 37	
	YTE001B	Bevel edge 51		Finish: sintered surface Thickness: 52	
	YTE001E	Sintered surface bevel edge 152		Finish: sintered surface Thickness: 152	
	YTE001G	Bevel edge 90		Finish: sintered surface Thickness: 90	
	YTE002A	Single board bevel edge		Finish: sintered surface	





Materials

LACQUER

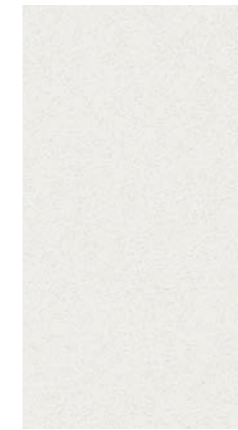

PWMK3007

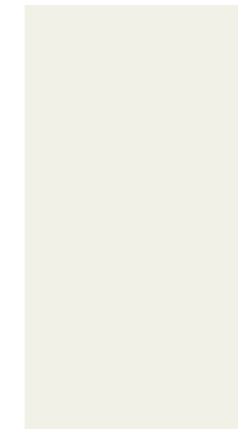

PWMK1018



PWMK1053



PWMK2006

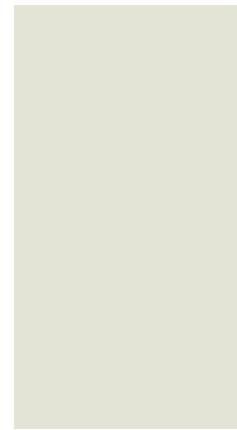

BWMK2010



BWMK2011

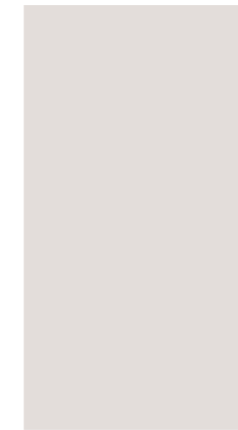

PWMK2014



BWMK2018

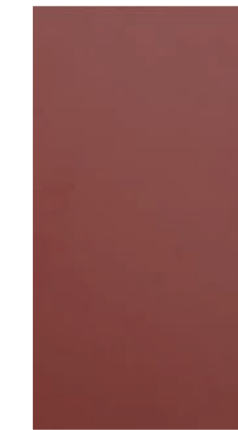

PWMK2146



MELAMINE



BWMA0013
BWFP0027



BWMA0025
BWFP0045



BWMA0046
BWFP0067

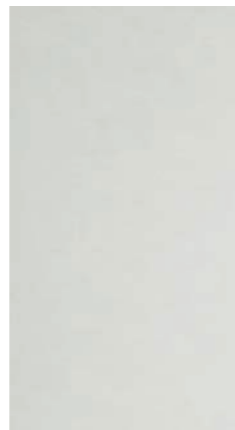

BWMA0047
BWFP0068



BWMA0052
BWFP0076



BWMA0084
BWFP0114

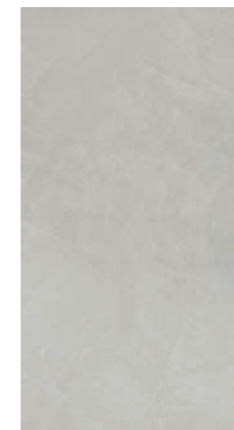

BWMA0085
BWFP0110

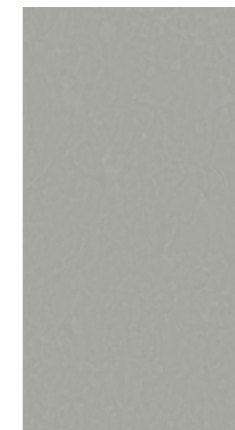

BWMA0086
BWFP0111

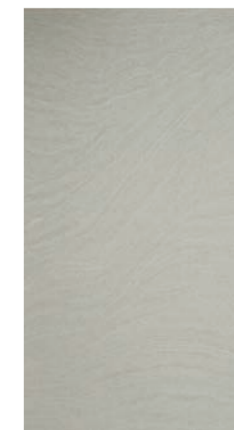

BWMA0087
BWFP0034

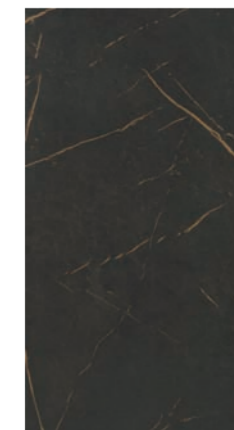

BWMA0104
BWFP0113



BWMA0056
BWFP0073



BWMA0070
BWFP0417



BWMA0071
BWFP0066



BWMA0074
BWFP0095



BWMA0083
BWFP0112

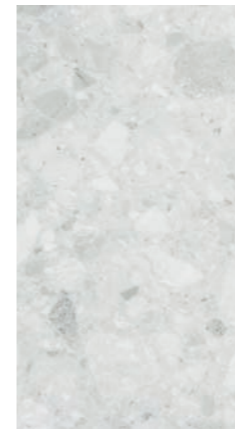

BWMA0105
BWFP0133



PWMA0157
PWFP0449



PWMA0215

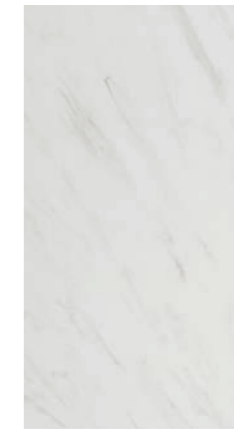

PWMA0128
PWFP0388

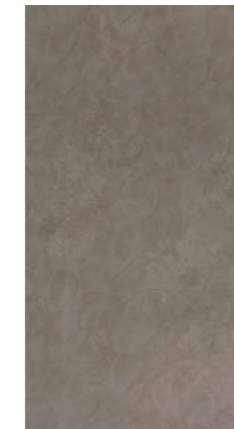

PWMA0381
PWFP0824



PWMA0386
PWFP0828

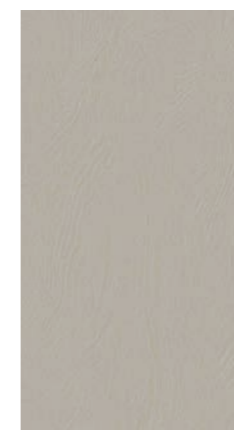

PWMA0387
PWFP0829



PWMA0196
PWFP0499



UV Lacquer Grade A



BWMC0019
BWFP0115

UV Lacquer Grade B



PWMC0019



PWMC0024
BWFP0093



PWMC0113
PWFP0822



PWMC0114
PWFP0823



PWMC0115
PWFP0827

UV Lacquer Grade B

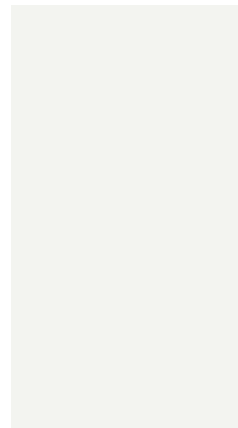

BWMC0001
BWFP0015

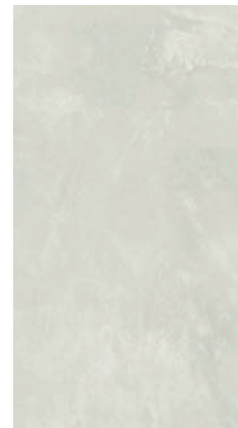

BWMC0009
BWFP0097

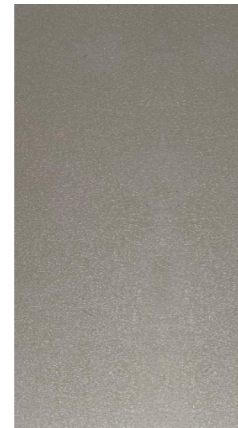

BWMC0013
BWFP0090



BWMC0015
BWFP0106



BWMC0016
BWFP0107



PWMC0116
PWFP0820



PVC FOIL

PVC Foil Grade A



BWMG0028



BWMG0034



PWMG0105



BWMG0046



BWMG0047



PWMG0287



PWMG0284

PVC Foil Grade B



BWMG0035

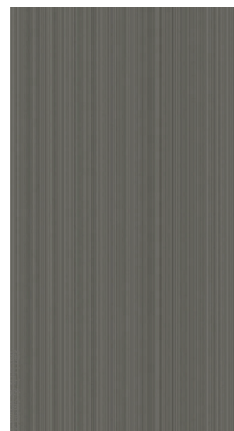

BWMG0044

BACK PANEL MATERIALS

Melamine

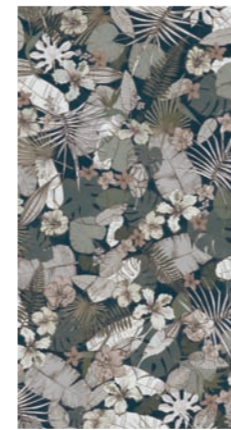

PWMA0355
PWFP0662



PWMA0382
PWFP0825

Metal Foil

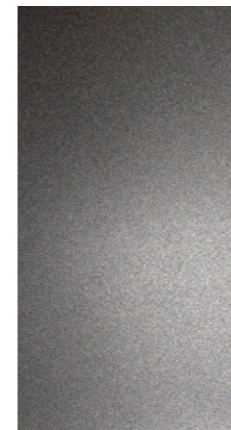

PWMJ0010A
PWMJ0010B
PWMJ0010C



PWMJ0011A
PWMJ0011B
PWMJ0011C



PWMJ0031
W1163*H12*D522



EDGE BANDING



BWFP0001(1.2*23mm)



BWFP0015(1.2*23mm)



BWFP0020(1.2*23/42/55mm)



BWFP0027(1.2*23mm)



BWFP0112(1.2*22mm)

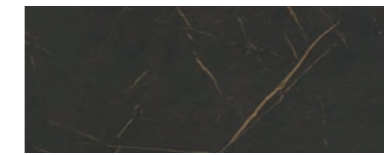

BWFP0113(1.2*22mm)



BWFP0114(1.2*22/42/55mm)



BWFP0115(1.2*23mm)



PWFP0034(1.2*23mm)

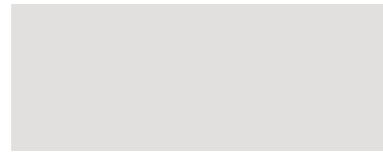

BWFP0045(1.2*23mm)



BWFP0066(1.2*23mm)



BWFP0067(1.2*23mm)



BWFP0133(1.2*22mm)



PWFP0417(1.2*23/55mm)



PWFP0449(1.2*23/42mm)



PWFP0451 (1.2*23mm)



BWFP0068(1.2*23mm)



BWFP0073(1.2*23mm)



BWFP0076(1.2*23mm)

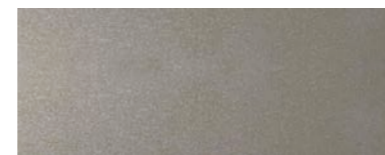

BWFP0090(1.2*23mm)



PWFP0662(1.2*23mm)



PWFP0820(1.2*22/42mm)



PWFP0822(1.2*22mm)



PWFP0823(1.2*22mm)



BWFP0093(1.2*23mm)

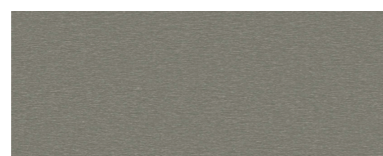

BWFP0095(1.2*23mm)



BWFP0096(1.2*55mm)

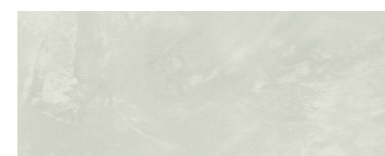

BWFP0097(1.2*23/42mm)



PWFP0824(1.2*22mm)



PWFP0825(1.2*22mm)



PWFP0827(1.2*22mm)



PWFP0828(1.2*22mm)

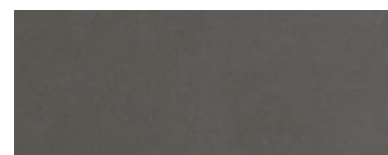

BWFP0106(1.2*23/55mm)



BWFP0107(1.2*23mm)

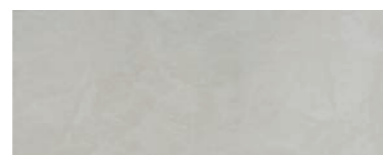

BWFP0110(1.2*22mm)

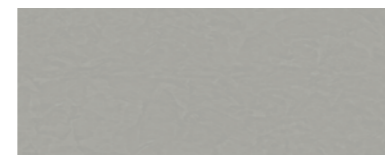

BWFP0111(1.2*22mm)

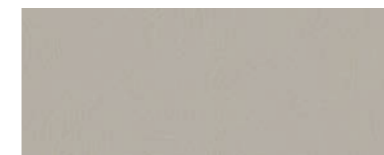

PWFP0829(1.2*22mm)



PWFP0499(1.2*23/55mm)



ALUMINUM EDGE BANDING

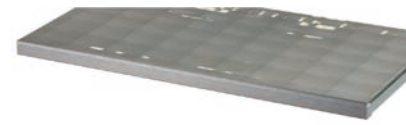

Code & Depth
PWFL0003
D= 8mm

Application
-Matching glass shelves

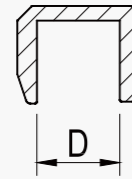

Code & Depth
PWFL0004
D=19/20/21mm

Application

-Applicable to door YMB008 and YMB006, and door thickness is 18-20mm.
-Matched with clip PWFL0004.

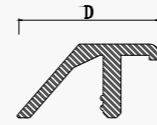

Code & Depth
PWFL0033
D=18-25mm

Application
-Material: Aluminum alloy
-Surface treatment: Anodizing
-Color: Gold

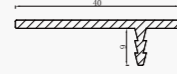

CARCASE



PWGA0017



PWGA0018

GLASS



Code: PWMB0002
Thickness: 5mm
Size: 1220mm×1830mm



Code: PWMB0005
Thickness: 5mm
Size: 1100mm×1650mm



Code: PWMB0010
Thickness: 5mm
Size: 1220mm×1830mm



Code: PWMB0098
Thickness: 5mm
Size: 1220mm×1830mm

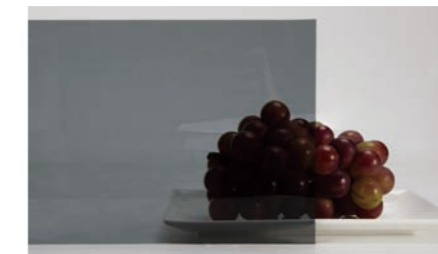

Code: PWMB0125
Thickness: 5mm
Size: 1220mm×1830mm



Code: PWMB0127
Thickness: 5mm
Size: 1830mm×2440mm



Code: PWMB0128
Thickness: 5mm
Size: 1830mm×2440mm



Code: PWMB0129
Thickness: 5mm
Size: 1830mm×2440mm



Code: PWMB0134
Thickness: 5mm
Size: 1830mm×2440mm

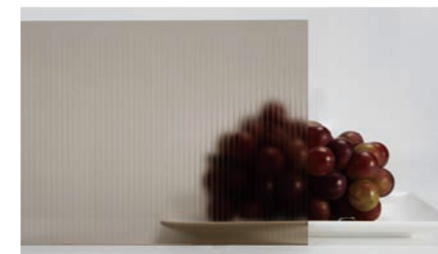

Code: PWMB0139
Thickness: 5mm
Size: 1830mm×2440mm

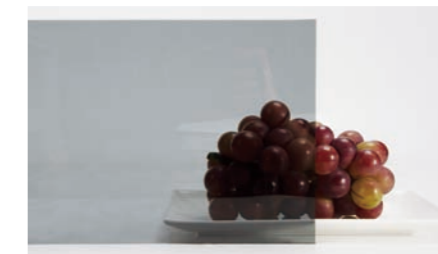

Code: PWMB0034
Thickness: 5mm
Size: 1830mm×2440mm



Code: PWMB0167
Thickness: 5mm
Size: 1830mm×2440mm



Glass



Quartzstone P3 Series



PWTY1026 (20mm)



PWTY1047 (20mm)



PWTY1048 (20mm)



PWTY1088 (20mm)

Quartzstone P1 Series



BWTY1001 (20mm)

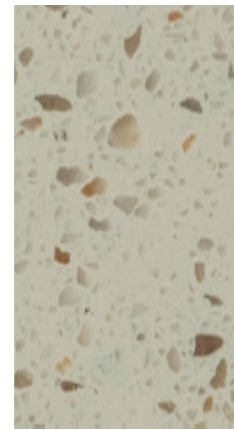

BWTY1002 (20mm)



BWTY1003 (20mm)

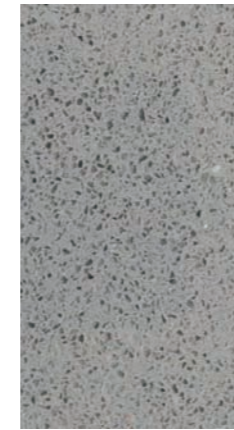

BWTY1020 (20mm)



PWTY1077 (20mm)

Sintered Surface

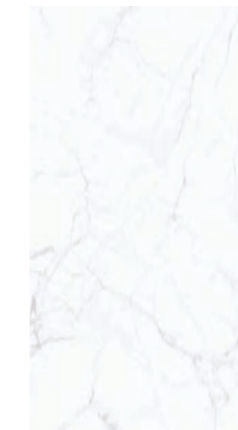

BWTE0005 (12mm)



BWTE0006 (12mm)



PWTE0049 (12mm)



PWTE0069 (12mm)



Flap Door Fittings



Code PWWA0001
Matched door height 720mm / 900mm
Matched door width (MDF based door) 800-1200mm / 600-750mm
Matched door width (solid wood/plywood/particle board based door) 900-1200mm / 600-800mm
Matched door width (aluminum framed glass door) 850-1200mm / 600-900mm

Application
 -Thickness of wood front and wood framed glass door must be within 18~21mm. Available for YML002, YML009.
 -Carcase net depth \geq 278mm, net height above cabinet $h= FH*0.44+38mm$, FH is upper door front height.
 -Energy-saving device LF: 5350-10150.
 -2 hinges required if door width \leq 900mm. 3 hinges required if $900 < W \leq 1200mm$.
 -Matched carcase height: 700-900mm.



Code PWWF0002
When installing 1 piece
Matched door height 360mm / 450mm / 540mm / 600mm
Matched door width 1000-1200mm / 900-1200mm / 900-1200mm / $900 \leq w < 1000$
When installing 2 pcs
Matched door height 600mm / 720mm
Matched door width $1000 \leq w \leq 1200mm$ / 900-1200mm

Application
 -Matching wood fronts and wood framed glass door, available for YML002, YML009.
 -Carcase net depth \geq 180mm, net height \geq 270mm
 -Opening angles available: 75°, 90°, 110°
 -2 hinges required if door width \leq 900mm. 3 hinges required if $900 < W \leq 1200mm$.
 -Matched carcase height: 350mm-800mm



Code PWWF0003
When installing 1 piece
Matched door height 360mm
Matched door width (MDF based door) 600-750mm
Matched door width (solid wood/plywood/particle board based door) 600-800mm
Matched door width (aluminum framed glass door) 700-900mm
When installing 2 pcs
Matched door height 360mm / 450mm
Matched door width (MDF base door) 900-1200mm / 600-1000mm
Matched door width (solid wood/plywood/particle board based door) 1100-1200mm / 700-1100mm
Matched door width (aluminum framed glass door) 1100-1200mm / 800-1200mm

Application
 -Thickness of wood front and wood framed glass door must be within 18~22mm. Available for YML002, YML009.
 -Carcase net depth \geq 125mm, net height \geq 200mm
 -2 hinges required if door width \leq 900mm. 3 hinges required if $900 < W \leq 1200mm$.
 -Energy-saving device LF: 800-1600.
 -Matching rebounder and rebounding hinge when in use.
 -Matched carcase height: 250mm-600mm

Flap Door Fittings



Code
PWWF0011
Matched door height
360/ 450
Matched door width (MDF based door)
600-800/ 600-700
Matched door width (solid wood/plywood/particle board based door)
600-950/ 600-800
Matched door width (aluminum framed glass door)
600-1000/ 600-900
Application
 -Matching narrow aluminum framed glass door YML003, YML003C, YML028, YML028A.
 -2 hinges required if door width ≤ 900mm. 3 hinges required if 900 < W ≤ 1200mm.
 -Standard configuration: 2 pics for 1 door panel.

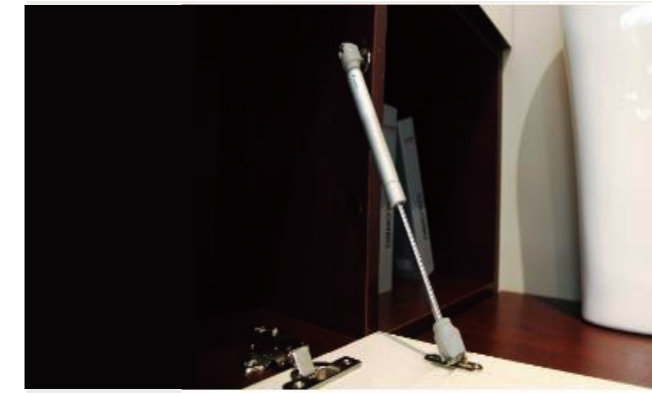

Code
BWWF0006
Application
 Matched door size: 300mm≤W≤1200mm, 300mm≤H≤500mm



Code
PWWF0015
When installing 1 piece
Matched door height
360mm
Matched door width (MDF based door)
600-800mm
Matched door width (solid wood/plywood/particle board based door)
600-850mm
Matched door width (aluminum framed glass door)
700-1000mm
Application
 -Thickness of wood front and wood framed glass door must be within 18~22mm.
 Available for YML002, YML009.
 -Energy-saving device LF: 800-1800
 -Carcase net depth ≥125mm, net height≥200mm
 -2 hinges required if door width≤900mm. 3 hinges required if 900 < W≤1200mm.
 -Matched carcase height: 250mm-600mm

When installing 2 pcs
Matched door height
360mm / 450mm
Matched door width (MDF base door)
950-1200mm / 600-1000mm
Matched door width (solid wood/plywood/particle board based door)
1100-1200mm / 700-1100mm
Matched door width (aluminum framed glass door)
1100-1200mm / 800-1200mm



Code
BWWF0008
When installing 1 piece
Matched door height
300/ 360/ 400
Matched door width
400-700/400-600/400-600
When installing 2 pcs
Matched door height
300/ 360/ 400/ 450/ 500
Matched door width
700-1200/650-1000/600-1000/550-900/600-800
Application
 -Matching particle board/ MDF based door, and door thickness≤19mm.
 -Opening angle: 80°
 -2 hinges required if door width ≤ 900mm.
 3 hinges required if 900 < W ≤ 1200mm.



Code
PWWF0030
Matched door height
360mm / 450mm / 540mm / 600mm
Matched door width (MDF based door)
800-1200mm / 500-1200mm / 600-1050mm / 600-850mm
Matched door width (solid wood/plywood/particle board based door)
900-1200mm / 600-1200mm / 400-1200mm / 400-1100mm
Matched door width (aluminum framed glass door)
1000-1200mm / 700-1200mm / 500-1200mm / 400-1100mm
Notes
 -This fitting matches 18-22mm thick wooden doors, wood-framed/aluminum-framed glass doors.
 Not available for YML003B/C, YML027A/B, YML028/A, YML030/A, YML036, YML037, YML038, YML039A/B.
 -Matched net carcase size: H' ≥ 173mm, L' ≥ 261mm.
 -Energy-saving device LF: 1730-5200.
Application
 -Hinges are not required.
 -Matched carcase height: 300-600mm. If the doors vary from the sizes and materials mentioned above, please consult with our designers.
 -When using aluminum-framed doors, 4*12mm cross self-driving screw is required for connecting fitting base and door panel.



Sliding Door Fittings



Code
PWWWT002F

Carcase net depth
D≥465mm+front panel thickness (Note: when the panel is built-in, carcase net depth need add front panel thickness)

Notes
Only for pulling-shelf drawer, without side panel, drawer depth is 438mm. W(drawer bottom panel) =W(carcase net width)-16mm



Code
PWWW0015(BM-BT02)

Name
Simple sliding door fitting

Application
-Suitable for wall cabinet, base cabinet, on-worktop cabinet
-Matching wood-based doors and wood framed doors which thickness≤22mm.
-Matching aluminum framed glass door YML002(LH-M05)



Code
PWWW0019

Door size
450mm ≤ W ≤ 1000mm, 300mm ≤ H ≤ 1200mm
The height of sliding door can not be 2 times larger than its width

Application
-Matching wooden doors, or wood framed glass door(frame width≥60mm).
-Thickness of top/bottom/shelf panel must be at least 18-19mm.
-Upper/lower slide available. Length=2.5m per pc (can be cut)
-Silent moving.
-Al-alloy edge bands/ Al-alloy handles are not available.
-When two sashes of sliding doors are installed, the gap between the two doors should be no less than 10mm.

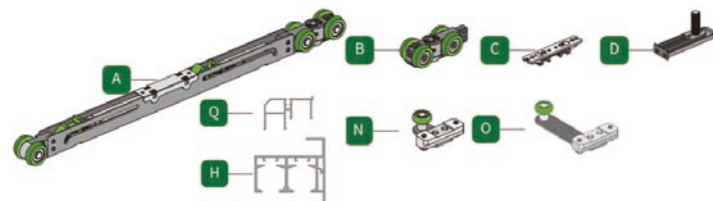

Code
PWWW0050A

Name
Sliding Door Pulley

Carcase net depth
-Equipped with upper and lower slides.
-Matching base cabinet, on-worktop cabinet, middle or high cabinet.
-Matched carcass thickness: 18-19mm
-Matching aluminum framed glass door YML062.

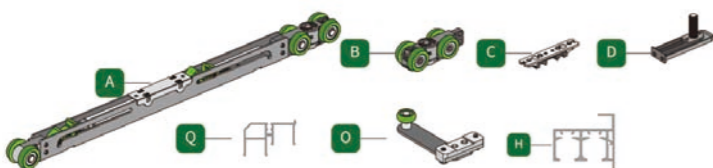

Code
PWWW0050B

Name
Outer Sliding Door Pulley

Carcase net depth
-Equipped with upper and lower slides.
-Matching base cabinet, on-worktop cabinet, middle or high cabinet.
-Matched carcass thickness: 18-19mm
-Matching aluminum framed glass door YML062.

SLIDING DOOR FITTINGS/ SLIDES

Slides

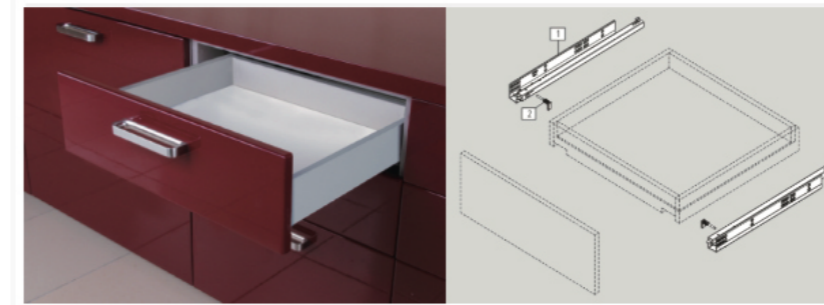

Code
PWWWP003A (NL=260)
PWWWP003C (NL=310)
PWWWP003D (NL=360)
PWWWP003E (NL=410)
PWWWP003F (NL=460)
PWWWP003G (NL=510)

Carcase net depth
265mm≤D < 315mm
315mm≤D < 365mm
365mm≤D < 415mm
415mm≤D < 465mm
465mm≤D < 515mm
515mm≤D

Notes
Drawer width=carcase net width-11mm



Code
BWWW001GA (H=84mm,NL=500mm)
BWWW001FA (H=84mm,NL=450mm)

Carcase net depth
D≥515mm
465mm≤D < 515mm

Drawer front height
117mm≤H < 197mm

Notes
-With integrated silent system
-Only applicable to 16mm thick bottom panel of drawer.
-Color of drawer side panel: white -Full extension



Code
BWWW001GB (H=135mm,NL=500mm)
BWWW001FB (H=135mm,NL=450mm)

Carcase net depth
D≥515mm
465mm≤D < 515mm

Drawer front height
197mm≤H < 247mm

Notes
-With integrated silent system -Only applicable to 16mm thick bottom panel of drawer.
-Color of drawer side panel: grey -Without white frosted tempered glass
-Full extension



Code
BWWW001GC (H=199mm, NL=500mm)
BWWW001FC (H=199mm, NL=450mm)

Carcase net depth
D≥515mm
465mm≤D < 515mm

Drawer front height
H≥247mm

Notes
-With integrated silent system -Only applicable to 16mm thick bottom panel of drawer.
-Color of drawer side panel: grey -Without white frosted tempered glass
-Full extension



Code
BWWW002A (NL=250)

Carcase net depth
265mm≤D < 315mm

Notes
Drawer width=carcase net width-10mm



Handles



Code & Depth
PWWK0003
D=19/20/21mm





Code & Depth
PWWK0003A
D=19/20/21mm



Code
PWWK0008
Handle treatment:
sandblasting & oxidation;
Application
Matching with 18mm-19mm thick
flat profile door, the standard size is
147,197,297,397,447,497,597,797,
897,997,1197

Code & Depth
PWWK0027
D=19/20/21mm
Application
For flat door only

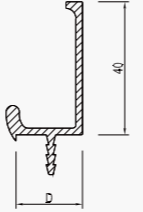
Code & Depth
PWWK0058
D=19mm





Code & Depth
PWWK0059
D=19mm





Code & Depth
PWWK0081
D=19mm



Code & Depth
PWWK0118
D= 20.95mm

Code
BWWK0012A/B/C
Notes
A: Length= 500mm,
only matching YMG131
B: Length= 900mm,
only matching YMG131
C: Length= 1200mm,
only matching YMG131

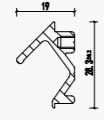

Handles (for Carcase)



Code
PWWK0002
(Silver)
PWWK0002B
(Black)
PWWK0002G
(Gold)





Code & Depth
PWWK0009 (Silver)
PWWK0009B (Grey)
D= 16.8mm



Code
PWWK0017C
PWWK0017

Code
PWWK0015C
PWWK0015

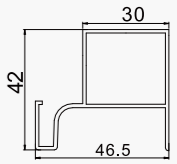

Standard Handles



Code	Hole distance	Total length	Height
PWWL0174	Single hole	36	22.5



Code	Hole distance	Total length	Height
PWWL0332	Single hole	32.4	25.7



Code	Hole distance	Total length	Height
PWWL0288	Single hole	33	25



Code	Hole distance	Total length	Height
PWWL0121	Single hole	37	28.5



Code	Hole distance	Total length	Height
PWWL0173	Single hole	35	20



Code	Hole distance	Total length	Height
PWWL0198	Single hole	20	30



Code	Hole distance	Total length	Height
PWWL0197A	Single hole	25	25



Code	Hole distance	Total length	Height
BWWL0002	96	125	25



Code	Hole distance	Total length	Height
BWWL0013	96	112.5	32.5



Code	Hole distance	Total length	Height
BWWL0063B	64	100	23.6



Code	Hole distance	Total length	Height
BWWL0064	160	167	25



Code	Hole distance	Total length	Height
PWWL0175	64	89	20



Code	Hole distance	Total length	Height
PWWL0002	128	152	26



Code	Hole distance	Total length	Height
PWWL0022	128	144	37



Code	Hole distance	Total length	Height
BWWL0047	160	166	30

Standard Handles



Code	Hole distance	Total length	Height
PWWL0042B	96	136	27



Code	Hole distance	Total length	Height
PWWL0056	96	132	25.5



Code	Hole distance	Total length	Height
PWWL0166	160	197.6	28



Code	Hole distance	Total length	Height
PWWL0166A	96	133.6	28



Code	Hole distance	Total length	Height
PWWL0194	64	103	24



Code	Hole distance	Total length	Height
PWWL0195	128	138	24



Code	Hole distance	Total length	Height
PWWL0176	128	170	32



Code	Hole distance	Total length	Height
PWWL0195A	128	138	24



Code	Hole distance	Total length	Height
PWWL0181A	160	172.5	30



Code	Hole distance	Total length	Height
PWWL0197B	96	115	34



Code	Hole distance	Total length	Height
PWWL0199	128	148	30



Code	Hole distance	Total length	Height
PWWL0257	128	139.5	30



Optional Handles

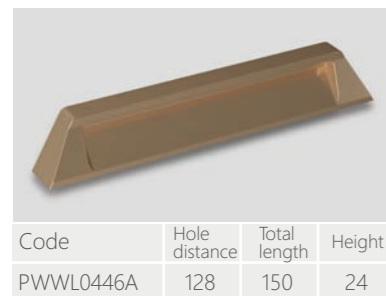

HANDLES & KNOBS

Optional Handles

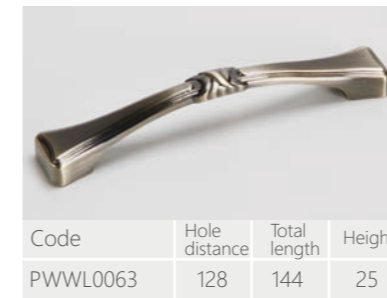

Faula Mobilier Hinges



Name Faula Mobilier 95° hinge with buffer
Code PWWM0052B
Notes Applied to half overlay doors, door thickness ≤ 22mm

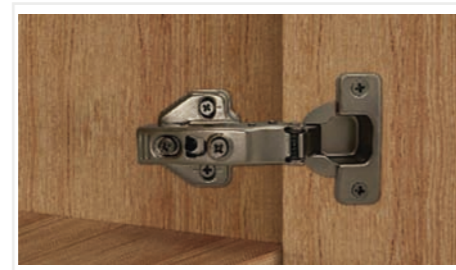

Name Faula Mobilier rebounding hinge
Code PWWM0108B
Notes Applied to thickened full overlay doors, door thickness ≤ 25mm, matching rebounder.

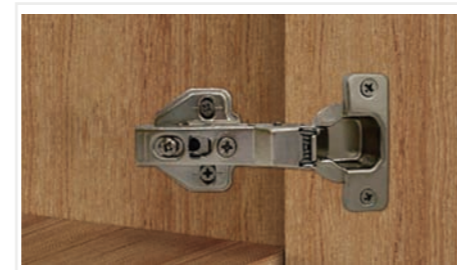

Name Faula Mobilier rebounding hinge
Code PWWM0109B
Notes Applied to thickened half overlay doors, door thickness ≤ 25mm, matching rebounder.

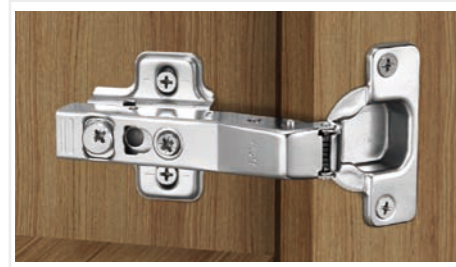

Name Faula Mobilier 45° hinge with integrated silent system
Code BWWM0008B
Notes Applied to pentagonal corner cabinets.



Name Faula Mobilier 180° hinge with integrated silent system
Code BWWM0009B
Notes Applied to linear corner cabinets.



Name Faula Mobilier quick assembly 155° hinge
Code BWWM0010B
Notes Applied to arc-shaped doors and carcass with inner drawers, full overlay. Soft closing.



Name Faula Mobilier quick assembly 95° hinge
Code BWWM0011B
Notes Applied to full overlay doors and door thickness > 22mm. Soft closing.



Name Faula Mobilier quick assembly 95° hinge
Code BWWM0012B
Notes Applied to half overlay doors and door thickness > 22mm. Soft closing.

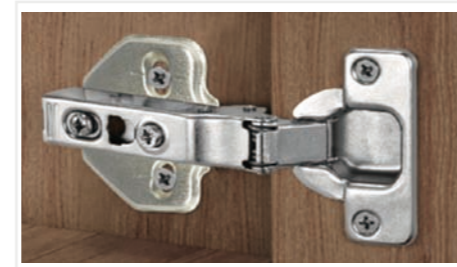

Name Faula Mobilier 110° hinge
Code PWWM0051B
Notes Applied to full overlay doors and door thickness ≤ 22mm. Soft closing.



Name DTC quick assembly 180° hinge
Code PWWM0296
Notes -Applied to thickened full overlay doors and linear corner cabinets.
 -Soft closing. -Color: Nickel

HINGES

Imported Hinges



Name Hettich hinge with integrated silent system
Code PWWM0012
Notes Applied to full-overlay doors and door thickness > 22mm



Name Hettich hinge with integrated silent system
Code PWWM0013
Notes Applied to half-overlay doors and door thickness > 22mm



Name Hettich hinge with integrated silent system
Code PWWM0015
Notes Applied to full-overlay doors and door thickness ≤ 22mm



Name Hettich 110° hinge with integrated silent system
Code PWWM0016
Notes Applied to half-overlay doors and door thickness ≤ 22mm



Name Hettich 95° hinge with integrated silent system
Code PWWM0038
Notes Applied to full-overlay aluminum framed doors



Name Hettich 95° hinge with integrated silent system
Code PWWM0039
Notes Applied to half-overlay aluminum framed doors



Name Hettich 180° hinge with integrated silent system
Code PWWM0040
Notes Applied to doors of linear corner cabinets



Name Hettich 165° hinge with integrated silent system
Code PWWM0044
Notes Applied to full-overlay arc doors or cabinets with inner drawers



Name Hettich 165° hinge with integrated silent system
Code PWWM0045
Notes Applied to half-overlay arc doors or cabinets with inner drawers

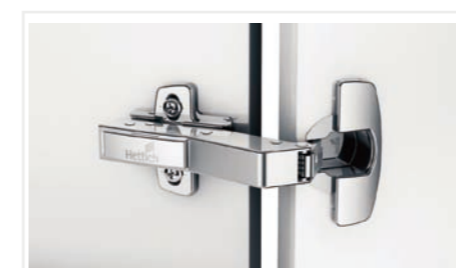

Name Hettich 45° hinge with integrated silent system
Code PWWM0046
Notes Applied to pentagonal corner cabinets, full overlay



Name Bearing type hinge (brass-tone)
Code PWWM0095A
Notes Applied to ≥ 22mm doors, only available for YML040A.



Name Bearing type hinge (gray)
Code PWWM0095B
Notes Applied to ≥ 22mm doors, only available for YML040B.



Imported Hinges



Name	SLICE Air Hinge (Italy)
Code	PWWM0076
Notes	Match aluminum-framed door YML030,YML030A, YML038,YML038A and door thickness is 18-19mm.

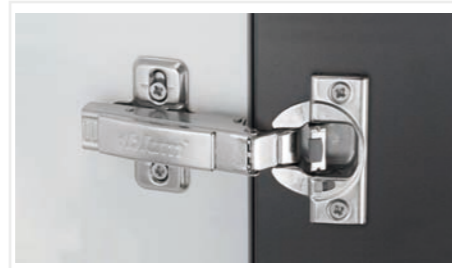

Name	Imported 107°hinge with integrated silent system
Code	PWWM0287
Notes	Applied to full-overlay doors, door thickness≤22mm

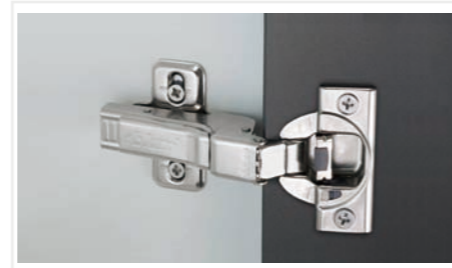

Name	Imported 107°hinge with integrated silent system
Code	PWWM0288
Notes	Applied to half-overlay doors, door thickness≤22mm



Name	Imported 95°hinge with integrated silent system
Code	PWWM0289
Notes	Applied to full-overlay thickened doors, door thickness > 22mm

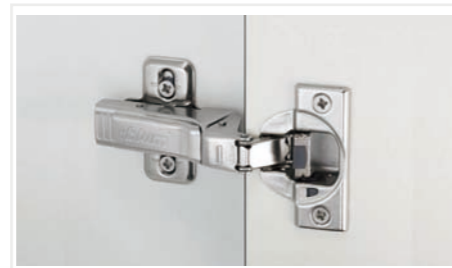

Name	Imported 95°hinge with integrated silent system
Code	PWWM0290
Notes	Applied to half-overlay thickened doors, door thickness > 22mm



Name	Hettich Quick assembly 95° hinge with silent system
Code	PWWM0293
Notes	-Applied to narrow aluminum-framed full overlay doors, door thickness≤32MM. -Color: Nickel

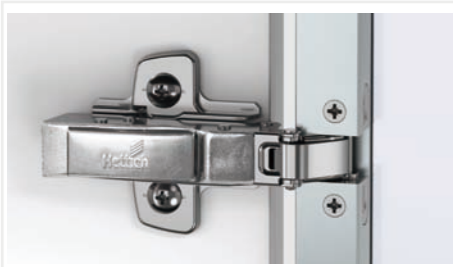

Name	Hettich Quick assembly 95° hinge with silent system
Code	PWWM0294
Notes	-Applied to narrow aluminum-framed half overlay doors, door thickness≤32MM. -Color: Nickel

Rebounder



Name	Magnetic rebounder
Code	BWWZ0002
Notes	Applied to handleless doors. Matching full-overlay rebounding hinge.

METAL LEGS/ KICKBOARDS

Metal Legs



Name	Al-alloy round leg (adjustable)
Code	PWNK0002/ PWNK0002A
Height	110mm-130mm / 160mm-180mm



Name	Stainless steel leg	Code	PWNK0043
Notes	-Size: H152*W68*D68 -Used for laundry cabinet -Height: 90-100mm, install at the bottom of the side panel		



Name	U-shape metal feet	Code	PWNQ0085
Note	-Size: D(580mm)*W(22.5)*h(13) -Block up 8mm, install on the 18mm thick side panel of balcony cabinet, sideboard and countertop		



Name	Stainless steel leg	Code	PWNK0055A/ PWNK0055B
Notes	-Size: H110-120*W101*D72 for PWNK0055A; H160-170*W101*D72 for PWNK0055B -Gold stainless steel leg (adjustable), installed at the bottom of the carcass.		



Name	Stainless steel leg	Code	PWNK0075A/ PWNK0075B
Notes	Stainless steel leg (adjustable), installed at the bottom of the carcass.		



Name	L-shaped metal leg	Code	PWNK0071
Height	-Height: 144mm, metal material with grey lacquered surface. -2 metal legs per set, installed on the left and the right side of sideboard.		

Plastic Leg



Code	PWNK0019A/PWNK0019B PWNK0019C/PWNK0019D
Height	80mm / 110mm 130mm / 160mm



Kickboards



Material
Metal foil
Code
PWND0003
Height
80mm / 105mm / 135mm / 155mm



Material
Black plastic
Code
PWND0005A / PWND0005B /
PWND0005C / PWND0005D
Height
80mm / 105mm /
135mm / 155mm



Material
Grey plastic
Code
PWND0006A / PWND0006B /
PWND0006C / PWND0006D
Height
80mm / 105mm /
135mm / 155mm



Material
Door panel
Code
YSJ011 / YSJ012 / YSJ013 / YSJ014
Height
80mm / 105mm / 135mm / 150mm

Bartop Legs



Name
Support Leg
Code
PWNB0019
Size
H=770/820/880/922mm,
W=600mm, D=51mm



Name
Round Leg
Code
PWNB0028A
Size
W=600/750mm,
H=740/830/870mm



Name
Round Leg
Code
PWNB0028B
Size
W=600/750mm,
H=740/830/870mm



Name
Metal Bartop Leg
Code
PWNB0018C/ PWNB0018D
Size
-PWNB0018C: W800×H700×D50mm.
Size of square tube: 50×30×2mm
-PWNB0018D: W590×H810×D50mm.
Size of square tube: 50×30×2mm

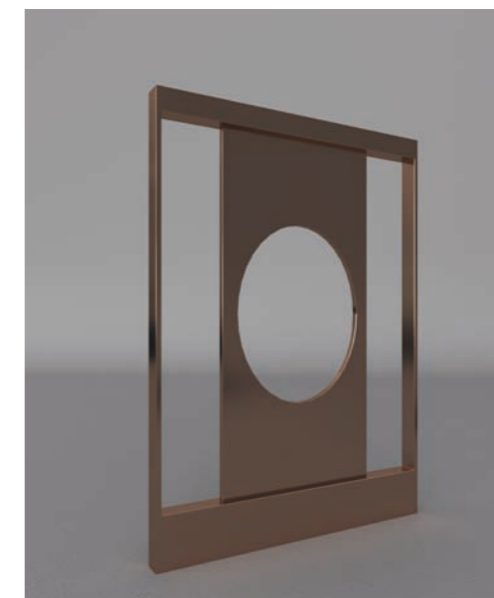

Name
Round Leg
Code
PWNB0031
Size
W750*H833*D50mm
(including food pad with
fixed size)



Name
Bartop Leg
Code
PWNB0033
Size
W1800*D850*H750mm



Bartop Legs



Name
Round Leg
Code
PWNB0032A
Size
W768*D842*H830mm



Name
Round Leg
Code
PWNB0032B
Size
W615*D238*H870 mm



Name
Support Leg
Code
PWNB0037
Size
-850*437*437mm (fixed size)
-Material: aluminum alloy, brass-tone paint for surface treatment.



Name
F-shaped Double Support Legs
Code
PWNB0038
Size
-H870mm, adjustable height range: 0-20mm
-Material: stainless steel, grey color, two legs per set (pads and metal legs included).
And the distance between the legs can be adjusted according to the bartop size.



Name
Metal Bartop Leg
Code
PWNB0039
Size
-Size: 200*200*720mm, adjustable range: 720mm-730mm
-Black matt paint for surface treatment.
-Including al-alloy adjustable leg, stainless steel round pole, iron pads and antislip mat.

Shelf Support



Name
Hanging Shelf Accessory
Code
PWNC0034
Note
-Including shelf stand column, shelf hanging part, carcass hanging part
-Height of shelf hanging part and carcass hanging part is adjustable, suitable for chamfered cabinet in 1380-2390mm height



Name
Shelf
Code
PWNC0042
Note
-Size: 400mm≤H≤1800mm
-Each shelf is matched with four brackets, four pins, two adjustable brackets
-Brackets suitable for inclined bottle holder



Name
Champagne-gold shelf partition
Code
PWNC0039
Note
-Matching decorative shelves for fixation or used as middle side panel.
-Installed Installed between the shelf support and the positioning buckle
-Matched decorative shelf size (W*H*D): 300mm≤W≤2400mm, H≤50mm, 240mm≤D≤400mm
-The number of decorative shelves should be no less than 2.s



Name
Glass shelf with light strip
Code
PWNC0067
Note
-Glass shelf with light strip, size: W462*H36*D525, color: brass brushed
-For wine glass storage.
-Including glass shelf, light strip and shelf clamp.



Name
Glass shelf with light strip
Code
PWNC0068
Note
-Glass shelf with light strip, size: W462*H45*D525, color: brass brushed
-For wine bottle storage.
-Including glass shelf, light strip and shelf clamp.



Name
Glass shelf with light strip
Code
PWNC0069
Note
-Glass shelf with light strip, size: W462*H36*D525, color: brass brushed
-Including glass shelf, light strip and shelf clamp.



Name
Metal shelf with light strip
Code
PWNC0040A
Note
-Size: W1200*H75*D287, color: Brass brushed



Name
Glass shelf with brass brushed metal frame
Code
PWNC0046A
Note
-With glass panels, size: W900*H75*D287
-Including L-shaped shelf and fittings.



Shelf Support



Name
Shelf bracket
Code
PWNC0005
Suitable materials
8~25mm thick glass or wood shelf



Name
T-shape bracket
Code
PWNC0006,
PWNC0006A
Suitable materials
Shelf depth: $250 \leq D < 400$; PWNC0006 suitable for wood shelf > 50 mm; PWNC0006A suitable for wood shelf $30 \leq D \leq 50$ mm; PVC available for $38 \leq D \leq 50$ mm thick



Name
Concealed shelf bracket
Code
PWNC0008
Suitable materials
Shelf thickness: 25mm-38mm;
 $150 \leq \text{depth} \leq 330$ mm



Name
Worktop Support
Code
PWNC0009
Size
210mm*210mm;
Match worktop or wood shelf



Name
Hanging set
Code
PWNC0038A
Note
-Including aluminum alloy shelf, back panel and accessories
-Width of aluminum alloy shelf: 600/900/1200/1500mm



Name
Al-alloy shelf
Code
PWNC0038B
Note
-Color: Brass brushed
-Including al-alloy shelves, light strips, back panel and other fittings.
-Width of al-alloy shelves with light strips: 600/900/1200/1500mm (fixed size).



Name
L-shaped grey metal shelf partition with light strip
Code
PWNC0045
Note
-Size: W600*H75*D287
-Including L-shaped shelf and fittings.



Name
L-shaped grey metal shelf partition with light strip
Code
PWNC0046
Note
-Size: W900*H75*D287
-Including L-shaped shelf and fittings.

Wine Rack



Name
Chrome wine rack
Code
PWNN0001
Note
-Size: W110mm×D300mm×H60mm
-Single layer

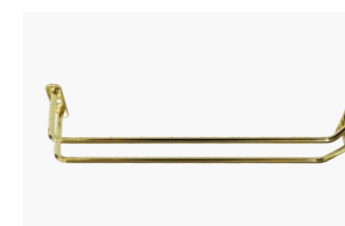

Name
Golden wine rack
Code
PWNN0002
Note
-Size: W110mm×D300mm×H60mm
-Single layer

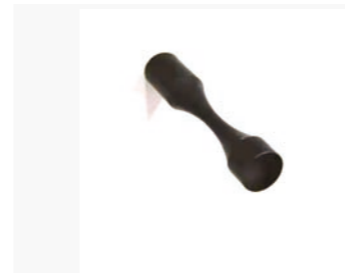

Name
Wine glass support
Code
PWNN0008
Note
-Size: D84*φ15mm
-Installed at sideboards, wine cabinets and walls.



Name
Black wine rack
Code
PWNN0009
Note
-Size: W105*D330*H43
-Able to fit small and limited space, maximizing space utility.
-Material: Iron, surface lacquered in black color.
-The diameter of wine glass rod is 4mm.



Name
Brassy wine rack
Code
PWNN0013A
Note
-Size: W100*D300*H18mm
-Installed on sideboard or wine cabinet to maximize space utility.



Name
Black matt wine rack
Code
PWNN0013
Note
-Two sizes available: 100*95*18mm/ 100*300*18mm
-For size 1 (100*95*18mm), applicable to metal open unit with wooden shelves. For size 2 (100*300*18mm), applicable to sideboard or wine cabinet to maximize space utility.



Name
Grey hanging wine rack
Code
PWNN0012A
Note
-Matched carcass width: 1000mm, required net inner height: 1395mm, net inner depth ≥ 450 mm.
-The space from the bottom panel of wine rack to the floor shall be at least 700mm or more.

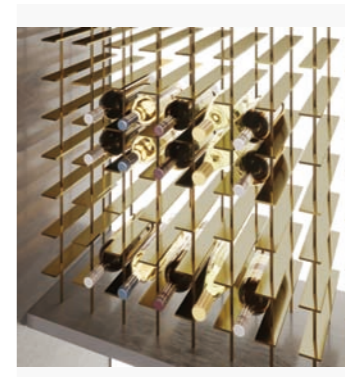

Name
Bronze hanging wine rack
Code
PWNN0012B
Note
-Matched carcass width: 900mm, required net inner height: 800mm, net inner depth ≥ 400 mm.
-The space from the bottom panel of wine rack to the floor shall be at least 700mm or more.



Name
U-shaped black wine rack
Code
PWNN0006
Note
-Size: W562×D288×H30mm
-Can store four rows of wine glasses.



Name
Grey wine rack
Code
PWNN0015
Note
-Size: W562*H45*D450
-For wine storage.
-Including glass shelves with light and shelf clamps.



Storage System



Name
Pivot Wire Basket
Code
PWNQ0079R, PWNQ0079L
Note
-Size: 380×300×150mm,
-Match 600mm wide middle or high cabinets.



Name
Dishes/Pots storage
Code
PWNQ0095
Note
-Main frame: powder sprayed on the surface of the steel plate
-Front: 5mm melamine
-Cabinet width: 600mm open cabinet
-Size: 530*480*145mm



Name
Food/tools storage
Code
PWNQ0096
Note
-Main frame: powder sprayed on the surface of the steel plate
-Front: 5mm melamine
-Cabinet width: 600mm open cabinet
-Size: 530*480*145mm



Name
Tea set/Vessels storage
Code
PWNQ0097
Note
-Main frame: powder sprayed on the surface of the steel plate
-Front: 5mm melamine
-Cabinet width: 600mm open cabinet
-Size: 530*480*90mm



Name
Storage Basket
Code
PBOLD006
Note
-Size: 350*525*105
-Matched door size: W≥447mm, H≥657mm, with flat core and straight edge
-Shelves are "d" indented. (d≥150mm)
-Installed behind the door panel



Name
Storage basket set
Code
PBOLD007
Note
-Size: W429*D166*H1185, match high cabinets
-Shall reserve H1 of carcass inner height for installation. (1100mm≤H1≤1200mm)
-Shelves are "d" indented. (d≥170mm)

Permeable Mesh



Name
80 mm Metal permeable mesh
Code
PWNQ0090A
Note
-Size: 20mm*78mm*597mm
-Suitable for small appliance cabinet



Name
120mm Metal permeable mesh
Code
PWNQ0090B
Note
-Size: 20mm*118mm*597mm
-Suitable for small appliance cabinet

Hanging System



Name
Wall Hanging Set No. 1
Code
PWNC0031
Note
-This set includes 2 wooden shelves, 2 glass shelves and 1 wine glass hanger.
-Glass shelf thickness=8mm, glass shelf width≤150mm and shelf length≤1200mm
-Wooden shelf thickness=18mm or 19mm, wooden shelf width≤150mm and shelf length≤1200mm



Name
Wall Hanging Set No. 2
Code
PWNC0032
Note
-This set includes 1 IPAD organizer, 1 hooker and 1 spice organizer.



Name
Wall Hanging Set
Code
PWNC0033
Note
-Including slot and installation parts
-Slot length 600mm≤L≤2400mm, installation parts length 10mm
-2 installation parts when slot length 600mm≤L≤900mm
-3 installation parts when slot length 900mm≤L≤2400mm

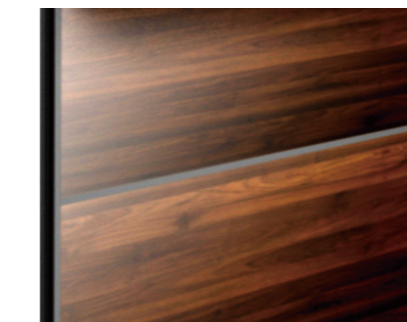

Name
Concealed wall-mounted filler
Code
PWNC0033A
Note
-Consist of base and decorative cover, matching wall hanging set PWNC0033, available for the filler of visible section
-Length: 450mm≤L≤2400mm
-Section thickness: 6mm



Name
Hidden hanging system- tower hanger
Code
PWNC0043
Note
-Size: 250W*45.5H*93D
-Matching PWNC0033 only.



Name
Hidden hanging set
Code
PWNC0044
Notes
-Size: D42*H47*L13
-Only suitable for PWNC0033



Name
Hook
Code
PWNC0044A
Note
-Size: D30*H47*L42
-Optional fitting, only matching wall hanging set PWNC0033.



Name
Metal open cabinet hook
Code
PWNQ0091
Note
-Size: 51H*21.8D*6W
-Only suitable for metal open cabinet PWNS0016A



Name
Pegboard
Code
PWNQ0054A
Note
-Size: 720W*600H*14D



Name
In-carcass hanging rod
Code
PWNS0079
Note
-Length: 400mm≤L≤1200mm
-Can be stalled in carcass, on wall/ door.
-Optional fittings: PWNC0032, PWNC0043, PWNC0044



Open Units



Name
Metal Open Cube

Code
PWNS0017

Size
-200mm≤W≤1200mm, 200mm≤D≤600mm and 200mm≤H≤2100mm
-Wooden shelf optional; matched wooden shelf thickness is between 16mm and 18mm; matched glass shelf thickness is 5mm.



Code
PWNS0040

Application
-Including proximate matter, connection, adjustable leg, support
-Height: 720mm-740mm, support depth 135mm
-Suitable for sink cabinet, work-on cabinet, balcony rack
-Choose the light strip according to length



Code
PWNS0042

Application
-Size: H1599*D540*W10
-Stainless steel material, suitable for open cabinet
-Matched with cabinet net height h≥1601mm, d≥540mm



Name
LED Metal Open Unit

Code
PWNS0047

Size
-Top/ bottom/ side/ middle side panels and shelves adopt aluminum alloy materials, with matte black oxidized surface. Light guide plate is used for back panel. Shelves are equipped with LED light stripes.
-Size limits: 150mm≤W≤1200mm, 150mm≤H≤2400mm, D=161.5mm. The number of shelves and middle side panels can be adjusted to meet design requirements.
-Inner size limits: 150mm≤H'≤400mm, 150mm≤W'≤1200mm.

Functional Accessories



Name
Al-alloy Open Unit

Code
PWNS0048(black)/PWNS0048A(brushed)

Size
-Compositions: 14mm thick Al-alloy panels (top/bottom/side/ middle side panels) + 9mm thick back panel (MDF core and black PVC foil finish) + top/ bottom panel lid + light strips (optional)
-When installed horizontally: 150mm≤W≤1200mm, 150mm≤H≤400mm, D=315mm.



Name
Double-layered Rack

Code
PWNS0049

Size
-Iron materials, black lacquer finish, and welding connection.
-Fixed size: 700H*750W*220D
-Max loading capacity: 30kg



Name
Gold Metal Open Unit

Code
PWNS0052

Size
-Compositions: 14mm thick gold Al-alloy panels (top/bottom/side/ middle side panels) + 9mm thick back panel (MDF core and brushed PVC foil finish) + top/ bottom panel lid + wine rack + light strips
-Fixed size: W1163*H291*D415mm
-The 3*3 grid pattern of the wine rack is welded by 2mm thick metal plate. Its fixed size is W'262*H'262*D'306mm.



Name
Metal Open Unit with Wooden Shelves/ Metal Open Rack

Code
PWNS0101(Metal Open Unit with Wooden Shelves)/
PWNS0103(Metal Open Rack)

Size
238mm≤W≤1200mm, 336mm≤H≤1740mm, D=140mm.
Net height must be 150mm≤H≤600mm. Shelves can be added or removed to match with each unit.



Open Units

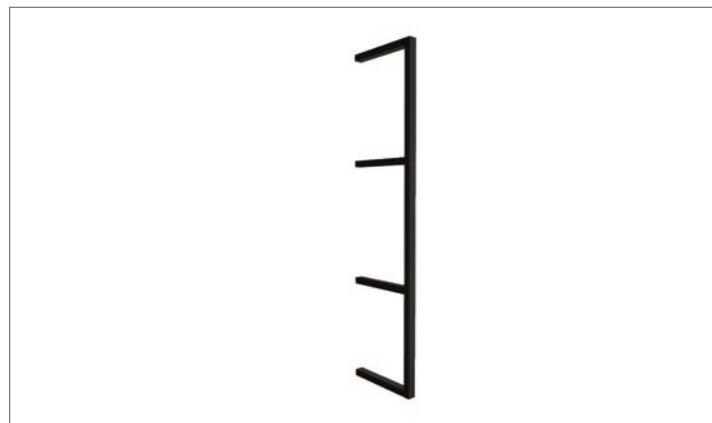

Name
Metal rack

Code
BWNS0004

Size

- Metal material with black lacquered surface.
- W20mm*D252mm*H974mm (fixed size)
- Matching shelf and back panel. Matched panel thickness: 18mm-25mm
- Equipped with 2 metal racks when 400mm≤W≤800mm.
- Equipped with 3 metal racks when 800mm < W≤1400mm.
- Equipped with 4 metal racks when 1400mm < W≤1800mm.



Name
Double-layer rack

Code
BWNS0005

Size

- W500mm*D220mm*H700mm (fixed size)
- Al-alloy material with gold lacquered surface.



Name
Metal Open Unit

Code
PWNS0078

Size

- Compositions: Al-alloy panels (top/bottom/side/middle side panels/shelves) + 9mm thick back panel (melamine coated)
- Size limits: 200mm≤W≤1200mm, 200mm≤H≤2400mm, D=148mm.
- Shelves/ middle side panel numbers can be adjusted, but should meet inner size limits: 182mm≤H'≤600mm, 182mm≤W'≤800mm.



Name
Metal Open Unit

Code
PWNS0051 (gold brushed)
PWNS0051B (black)

Size

- Top/ bottom/ side/ middle side panels and shelves adopt aluminum alloy materials. The back panel is 18mm thick panel coated with melamine PWMA0119
- Size limits: 200mm≤W≤1200mm, 200mm≤H≤2400mm, D=148mm
- The number of shelves and middle side panels can be adjusted. But the net height should be 182mm≤H'≤600mm, the width should be 182mm≤W'≤800mm.

Functional Accessories

Others



Name
W450 Seasoning Pull Out

Code
PWNQ0027

Note

- Carcase panel thickness: 16mm
- Wall cabinet size: W450mm*H700-900mm*D330-350mm
- Load capacity: 1.5KG

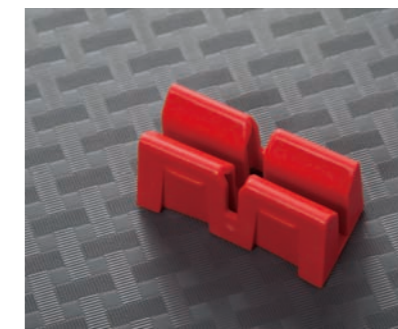

Name
Connection buckle

Code
PWNQ0081F

Suitable materials

- Separator including L-shape separator, E-shape separator, division box, T-shape division box and connection buckle
- Suitable for drawer depth between 350-560mm



Name
Hidden folding countertop

Code
PWNQ0098

Note

- Cabinet net depth: D≥390mm, load-bearing: 30KG, interior height: H≥180mm, pull-out extension L=370mm
- Suitable width: 400-1000mm
- Suitable for high cabinet, base cabinet



Name
Waterproof pad

Code
PWNQ0099

Note

- Only suitable for sink cabinet with 900mm width and 560mm depth
- Each square meter can hold 6L water

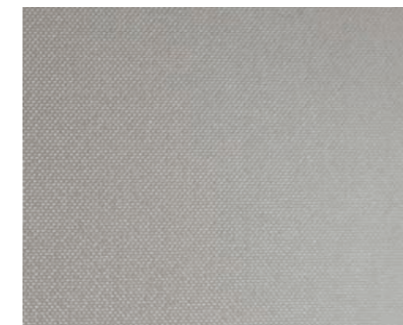

Name
High-end non-slip mat

Code
PWNQ0100

Note

- Size: 500mm*2100mm, can be customized as required.
- Heat-proof mat: Option A in high-end series. Dark grey surface with delicate texture.



Name
Safety lock

Code
PWW50006

Note

- Concealed design, with no keyholes.
- Safe locking, keeps kids away from dangerous goods.
- For Base cabinets in kitchen, only available for wooden door (melamine/ HPL)

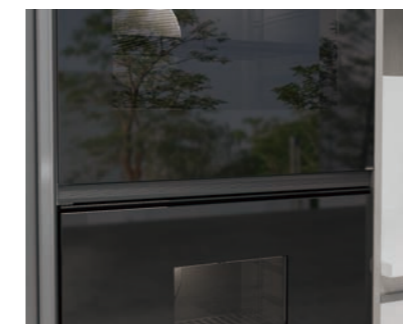

Name
Appliance cabinet accessory

Code
PWNQ0146

Note

- Black matt al-alloy edge band (length=597), matching 10mm thick appliance shelf and bottom panel.
- Equipped with 4 stainless steel fittings for fixation.
- Available for 16 mm thick shelves and bottom panels of appliance cabinet.
- To prevent the scene of an exposed shelf and aluminum foil of appliance cabinet.



Name
Al-alloy backsplash

Code
PWNQ0147

Note

- Color: grey, size: H35*D18*, can be customized as required. Presenting a more pleasing look, compared to regular backsplashes.
- Fixed with countertop glue instead of backsplash strip.
- Equipped with plastic cover and end caps.



Name
Champagne-gold hanging rod

Code
PWNT0008



Power Supply System



Name
Intelligent electric lifting socket
Code
PBZP0065
Note
-Size: 110V-250V~50/60Hz Max 12A
-AI remote control, wireless charging, bluetooth speaker, automatic concealed lifting, DC-cord socket
-Countertop cutting hole size: Ø102mm, wire length: 1.7m



Name
Embedded wireless charger
Code
PBZP0069
Note
-Embedded design; fast wireless charging for phones (supporting power up to EPP 15W max)
-Input: 12V1.5A; output: 5W/7.5W/10W/15W
-Countertop cutting hole size: Ø90mm, D≥25mm.



Name
Grey electric track
Code
PBZP0081
Note
-Size: 600mm, 900mm, 1200mm, 1600mm. Length can be adjusted.
-Installation: surface-mounted or imbedded in the shelf fronts.
-Matching mobile socket.

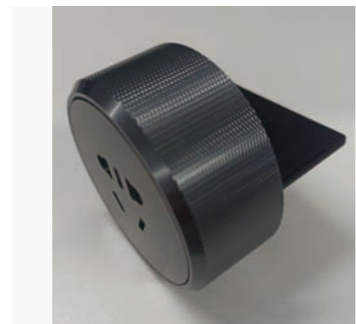

Name
Five-hole round grey socket
Code
PBZP0083
Note
-Size: Φ70*30mm
-Matching electric track.
-Installed on the electric track on the wooden shelf.



Name
Five-hole square socket
Code
PBZP0084
Note
-Size: W69mm*D104mm*H35mm
-Matching electric track.
-Installed on the electric track vertically mounted on the countertop.



Name
Square USB socket
Code
PBZP0085
Note
-Size: W69mm*D69mm*H35mm
-Matching electric track.
-Installed on the electric track vertically mounted on the countertop.



Name
Multifunctional charger
Code
PBZP0087
Note
-Size: Φ114.6*102mm. Built-in installation, countertop hole size: Φ103mm.
-Electric lifting. Both wireless charging and wired charging available. With heating and cooling function.
-Working voltage: DC24V



Name
Black mobile socket and track
Code
PBZP0107A/ PBZP0107B
Note
- PBZP0107A: Length= 600mm, rated Voltage= 250V, frequency= 50Hz, max output current= 16A, max power= 4000W.
- PBZP0107B: Length=900mm, rated Voltage= 250V, frequency= 50Hz, max output current= 16A, max power= 4000W.
-Built-in installation. Available for five-hole socket and USB socket.

Lights



Name
K04 Bar handle light
Code
PWNQ0089A
Note
-Section size same as PWWK002, craft same as PWWK002
-Surface in black brushed color
-Power: 60W, voltage specification: DC24V, for both electric track and light strip.
-Matching 24V remote control for lightness adjustment.

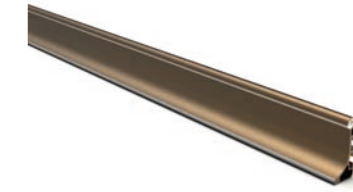

Name
K04 Bar handle light
Code
PWNQ0089B
Note
-Section size same as PWWK002, craft same as PWWK002
-Surface in brass brushed color
-Power: 60W, voltage specification: DC24V, for both electric track and light strip.
-Matching 24V remote control for lightness adjustment.



Name
K04 Bar handle light
Code
PBZQ0062
Note
-Length can be customized.
-Integrated handle with lighting, installed on the bottom panel of wall cabinet.
-Voltage specification: 12V, color temperature: 4000K

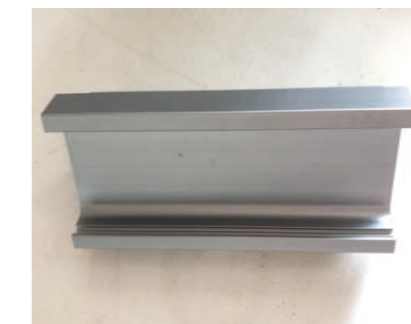

Name
Grey bar handle light
Code
PWWK0072
Note
-D=16.5mm
-Vertically mounted



Name **Code**
Bar handle light PWWK0072A
Note
-Section size same as PWWK0017, craft same as PWWK0017.
-Vertical installation, surface in brass brushed color
-Power: 60W, voltage specification: DC24V, for both electric track and light strip.
-Matching 24V remote control for lightness adjustment.



Name
Bar handle light
Code
PWNQ0089
Note
-Section size same as PWWK002, craft same as PWWK002
-Surface gun grey
-Power: 60W, voltage specification: DC24V



Name
Bar handle light (for one side only)
Code
PWWK0100
Note
-Section size same as PWWK0015, craft same as PWWK0015.
-Vertical installation, surface in silver color.
-Power: 60W, voltage specification: DC24V, for both electric track and light strip.
-Matching 24V remote control for lightness adjustment.



Name **Code**
Bar handle light PWWK0100A
(for one side only)
Note
-Section size same as PWWK0015, craft same as PWWK0015.
-Vertical installation, surface in brass brushed color
-Power: 60W, voltage specification: DC24V, for both electric track and light strip.
-Matching 24V remote control for lightness adjustment.



Lights

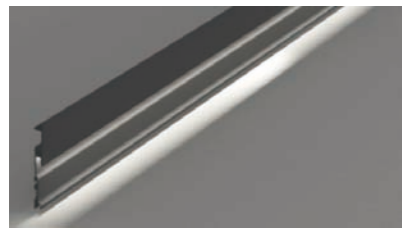

Name
Al-alloy kickboard with light strip

Code
PWND0013D

Note
-Al-alloy kickboard, surface oxidated in grey color, H=155mm
-Length: 3000mm. Wire at two ends. Can be customized as required.
-Voltage specification: 12V, color temperature: 4000K.

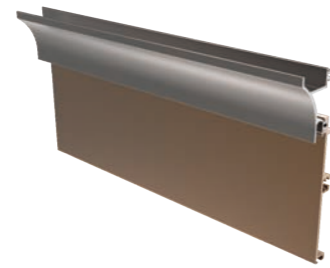

Name
Kickboard with light strip

Code
PWND0014B/C

Note
-Size of PWND0014B: H105mm, size of PWND0014C: H135mm.
-Upper profile: silver color, lower part: brass brushed, embedded with LED light strips
-Equipped with plastic cover and soft silicone light strip.

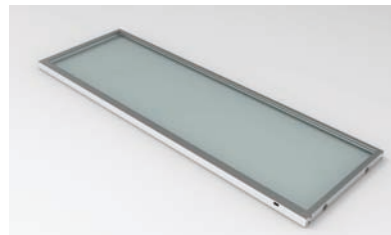

Name **Code**
Silver Al-alloy Glass Shelf PWNC0061A/C

Note
-Size of PWNC0061A: 417mm/567mm/413mm/563mm*295mm*20mm; size of PWNC0061C can be customized.
-Frame: silver al-alloy color, matte finish, embedded with LED light strips
-Inset: glass, equipped with 4 shelf clamps.
-Touch-sensitive system controls lightness. Light power: 6w; color temperature: 4000K.



Name
Silver surface mounted kickboard light

Code
PBZL0019

Note
-L=3000mm, outgoing at both ends, cut according to drawing, embedded design.
-Supply voltage: 12V; color temperature: 4000K



Name
Aluminum beam with light strip

Code
PBZT0011/ PBZT0011A

Note
-Fixed size for PBZT0011A: 767mm and 867mm, matching base cabinet of 800/900mm width. PBZT0011 can be customized as required.
-Installed on base cabinet, and equipped with gate-control switch, substitute for original base cabinet aluminum beam.
-Voltage specification: DC12V, color temperature: 4000K.



Name
Sterilizing aluminum beam with light strip

Code
PBZT0012/ PBZT0012A

Note
-Fixed size for PBZT0012A: 767mm and 867mm, matching base cabinet of 800/900mm width. PBZT0012 can be customized as required.
-Installed on base cabinet, and equipped with gate-control switch, with sterilizing and cleaning features, substitute for original base cabinet aluminum beam.
-Voltage specification: DC12V, color temperature: 4000K.



Name
Aluminum crossbar light strip

Code
PBZT0009A/PBZT0009

Note
-Standard size of PBZT0009A: 768mm/ 868mm, matching 800/900mm base cabinet.
-Nonstandard Size of PBZT0009 should be customized.
-Installed at aluminum crossbar position in base cabinet, with concealed door-controlled switch.
-Supply voltage: 12V; color temperature: 4000K



Name
Surface-mounted sterilizing light strip

Code
PBZQ0063

Note
-Length: 417mm/567mm/867mm/1167mm.
-Installed at the bottom of wall cabinet, with sterilizing feature.
-Voltage specification: DC12V, color temperature: 4000K.



Name **Code**
Luminous back panel PBZQ0064

Note
-Size: W461*H2300.5*D18mm/W863*H1762.5*D18mm/ W961*H2300.5*D18mm/ W1163*H1623*D18mm/W342*H683*D18mm/ W1163*H2363*D18mm/W563*H2122.5*D18mm.
-Installed at the back of carcass, substitute for back panel, for back lighting and ambient lighting.

Functional Accessories

Lights



Name
Light strip

Code
PBZL0018

Note
-Length: 3000mm, size can be customized to meet requirements, and should be cut from the wireless end.
-Built-in installation.
-Voltage specification: 12V, color temperature: 4000K.



Name
Surface mounted light strip

Code
PBZL0022A/B/C/D

Note
-Size: PZL0022A: 417mm, PZL0022B: 567mm, PZL0022C: 867mm, PZL0022D: 1167mm
-Installed inside the wall cabinet/ at its base panel
-Supply voltage: 12V; color temperature: 4000K



Name
Wooden shelf light strip

Code
PBZC0056

Note
-Size: can be customized as required.
-Installed at the open unit/ wall cabinet/ middle or high cabinet/ wooden shelf.
-Supply voltage: 12V, color temperature: 4000K



Name
Glass shelf light strip

Code
PBZC0057

Note
-Size: can be customized as required.
-Installed at 8mm-10mm thick glass shelves.
-Supply voltage: 12V, color temperature: 4000K



Name
45 degree luminous imbedded light strip (left)

Code
PBZQ0061A

Note
-Size: can be customized as required.
-Imbedded in left side panel, top panel or shelf of middle/ high cabinet.
-Supply voltage: 12V, color temperature: 4000K



Name
45 degree luminous imbedded light strip (right)

Code
PBZQ0061B

Note
-Size: can be customized as required.
-Imbedded in right side panel of middle or high cabinet.
-Supply voltage: 12V, color temperature: 4000K



Light Control System

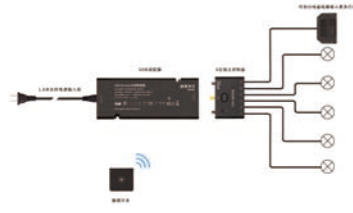

Name
60W Lighting Control System
Code
PBZP0057
Note
-Equipped with 60W power adaptor*1 set,
6 digits individual control box*1 set,
1 distribution box, 1 touch switch.
-12V output voltage, 60W power.



Name
Hand scan sensor switch
Code
PBZP0064A
Note
-Matching 60W lighting control system
(PBZP0057)
-Optional external switch,
separate installation.

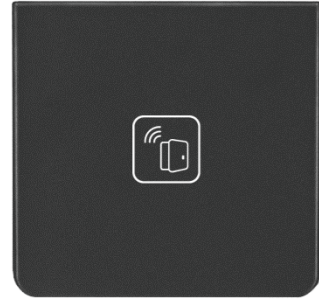

Name
Gate controlled switch
Code
PBZP0064B
Note
-Matching 60W lighting control system
(PBZP0057)
-Optional external switch,
separate installation.



Name
Human body sensor switch
Code
PBZP0064C
Note
-Matching 60W lighting control system
(PBZP0057)
-Optional external switch,
separate installation.

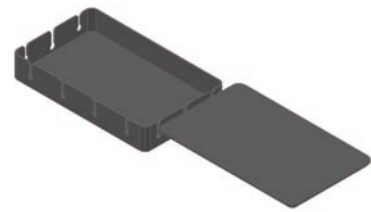

Name
Wire Organizing Box
Code
PWNQ0132
Note
-Size: 250*150*40mm
-Suitable for driver and wire of lighting



Name **Code**
Glass-gate controlled switch PBZP0086
Note
-3 switch modes:
1. Gate controlled mode. (Light's on when door opens, light's off when door closes).
2. Hand scan mode. (Light's on when hand is sensed. Lightness can be adjusted when hand is placed at a point 3cm away from the switch for 2 seconds. Then light's off if hand is sensed again.)
3. Personalized mode. (100% lightness when door is closed, 30% lightness when it is open. Suitable for display cabinet with glass doors. The lightness can come to its full with doors closed for the best display effect. The dimming with doors opened could protect eyes from glare.)

Functional Accessories

Drawer Dividers

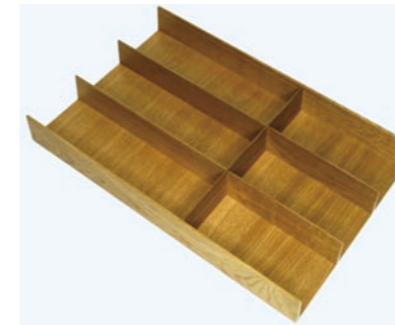

Name
Multi-functional separator
Code
PBOFD020A
Size
-300*472*49mm



Name
Multi-functional separator
Code
PBOFD020B
Size
-152*472*49mm

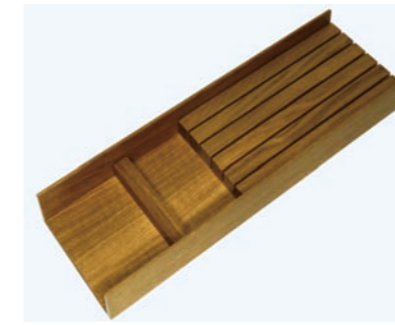

Name
Drawer organizer & knife block
Code
PBOFD020C
Note
-Size: 137*472*26mm
-Matching separator PWNQ0133B



Name
Multi-functional separator
Code
PBOFD020D
Note
-Size: 137*472*45mm
-Matching separator PWNQ0133B

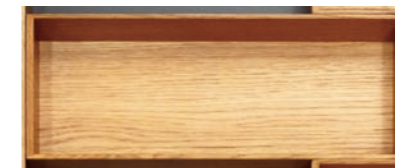

Name
Multi-functional separator
Code
PBOFD020E
Note
-Size: 300*117.5*49mm



Name
Drawer organizer
Code
PBOFD020F
Note
-Size: 236*472*120mm
-For tall drawer

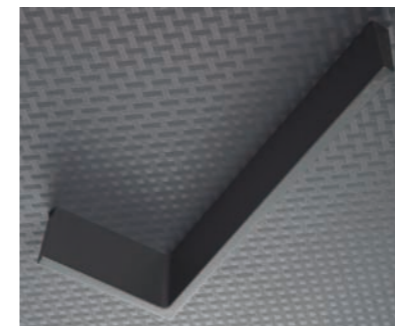

Name
L-shape separator
Code
PWNQ0081A(left),
PWNQ0081B(right)
Note
-Size: 100mm*250mm*44mm
-Suitable for drawer depth
between 350-560mm

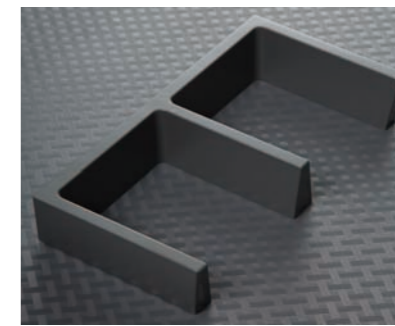

Name
E-shape separator
Code
PWNQ0081C
Note
-Size: 100mm*200mm*44mm
-Suitable for drawer depth
between 350-560mm

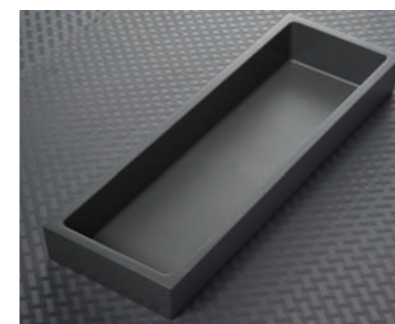

Name
Division box
Code
PWNQ0081D
Note
-Size: 100mm*300mm*44mm
-Suitable for drawer depth
between 350-560mm



Name
T-shape division box
Code
PWNQ0081E
Note
-Size: 200mm*400mm*44mm
-Suitable for drawer depth
between 350-560mm



CONFIGURATION TABLES

Drawer Divider Solutions (Depth=450/500mm)						
Drawer Width	W=450mm	W=500mm	W=600mm	W=700mm	W=800mm	W=900mm
Option 1 (Diagram)						
Compos	PWNQ0081A*1; PWNQ0081B*1; PWNQ0081D*1; PWNQ0081F*2	PWNQ0081A*1; PWNQ0081B*1; PWNQ0081E*1; PWNQ0081F*2	PWNQ0081A*4; PWNQ0081E*1; PWNQ0081F*4	PWNQ0081A*2; PWNQ0081C*2; PWNQ0081D*1; PWNQ0081E*1; PWNQ0081F*4	PWNQ0081A*2; PWNQ0081C*2; PWNQ0081E*2; PWNQ0081F*4	PWNQ0081C*4; PWNQ0081D*2; PWNQ0081E*2; PWNQ0081F*7
Option 2 (Diagram)						
Compos	PWNQ0081B*1; PWNQ0081E*1; PWNQ0081F*2	PWNQ0081A*1; PWNQ0081C*2; PWNQ0081E*1; PWNQ0081F*3	PWNQ0081C*2; PWNQ0081D*2; PWNQ0081E*1; PWNQ0081F*4	PWNQ0081A*4; PWNQ0081C*2; PWNQ0081E*1; PWNQ0081F*6	PWNQ0081C*2; PWNQ0081D*2; PWNQ0081E*1; PWNQ0081F*5	PWNQ0081A*4; PWNQ0081C*2; PWNQ0081E*2; PWNQ0081F*6
Option 3 (Diagram)						
Compos	PWNQ0081C*2; PWNQ0081E*1; PWNQ0081F*2	PWNQ0081C*4; PWNQ0081E*1; PWNQ0081F*4	PWNQ0081C*4; PWNQ0081D*1; PWNQ0081E*1; PWNQ0081F*5	PWNQ0081A*1; PWNQ0081C*2; PWNQ0081D*2; PWNQ0081E*1; PWNQ0081F*5	PWNQ0081C*4; PWNQ0081D*1; PWNQ0081E*2; PWNQ0081F*6	PWNQ0081C*2; PWNQ0081D*2; PWNQ0081E*2; PWNQ0081F*6
Drawer Divider Solutions (Depth=350/400mm)						
Drawer Width	W=450mm	W=500mm	W=600mm	W=700mm	W=800mm	W=900mm
Option 1 (Diagram)						
Compos	PWNQ0081A*1; PWNQ0081B*1; PWNQ0081D*1; PWNQ0081F*2	PWNQ0081A*1; PWNQ0081B*1; PWNQ0081D*1; PWNQ0081F*2	PWNQ0081C*1; PWNQ0081D*3; PWNQ0081F*4	PWNQ0081C*2; PWNQ0081E*1; PWNQ0081F*3	PWNQ0081C*2; PWNQ0081D*1; PWNQ0081E*1; PWNQ0081F*4	PWNQ0081C*1; PWNQ0081D*2; PWNQ0081E*1; PWNQ0081F*3
Option 2 (Diagram)						
Compos	PWNQ0081B*3; PWNQ0081D*1; PWNQ0081F*3	PWNQ0081B*3; PWNQ0081D*1; PWNQ0081F*3	PWNQ0081C*4; PWNQ0081D*1; PWNQ0081F*4	PWNQ0081D*2; PWNQ0081E*1; PWNQ0081F*2	PWNQ0081D*2; PWNQ0081E*1; PWNQ0081F*2	PWNQ0081D*2; PWNQ0081E*1; PWNQ0081F*2
Option 3 (Diagram)						
Compos	PWNQ0081B*3; PWNQ0081C*1; PWNQ0081F*3	PWNQ0081D*3; PWNQ0081F*2	PWNQ0081C*2; PWNQ0081E*1; PWNQ0081F*3	PWNQ0081C*1; PWNQ0081D*1; PWNQ0081E*1; PWNQ0081F*3	PWNQ0081C*1; PWNQ0081D*2; PWNQ0081E*1; PWNQ0081F*3	PWNQ0081C*1; PWNQ0081D*2; PWNQ0081E*1; PWNQ0081F*3

2022 Configuration Table of Door Panel Patterns of Faula Mobilier Kitchen Cabinets						
Materials	Code	Size of Raw Panel	Pattern Direction	Diagram (A: W*H is the size of door panel. B: the size of raw panel)	Main Pattern	Pattern for Drawer/ Flap Doors
Melamine	PWMA0386	2440*1220*18	Horizontal		Vertical strip	Horizontal strip
	PWMA0381	2440*1220*18	Horizontal		Vertical strip	Horizontal strip
	PWMA0387	2440*1220*18	Horizontal		Vertical strip	Horizontal strip
	BWMA0009	2440*1220*18	Horizontal		Vertical strip	Horizontal strip
	BWMA0046	2440*1220*18	Horizontal		Vertical strip	Horizontal strip
	BWMA0052	2440*1220*18	Horizontal		Vertical strip	Horizontal strip
	BWMA0070	2440*1220*18	Horizontal		Vertical strip	Horizontal strip
	BWMA0085	2440*1220*18	Horizontal		Vertical strip	Horizontal strip

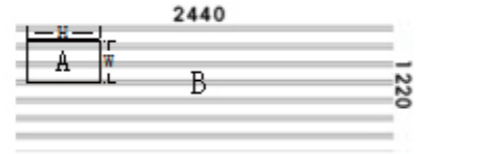
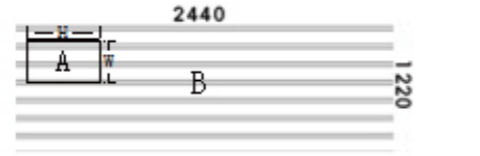
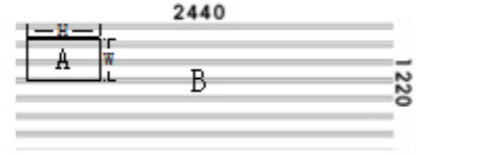
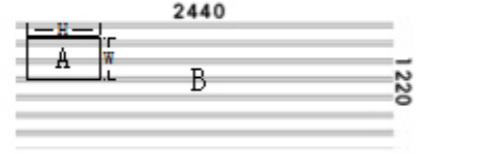
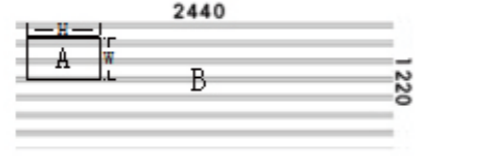
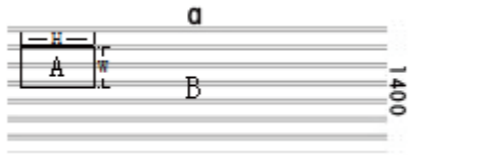
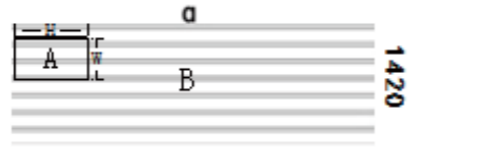
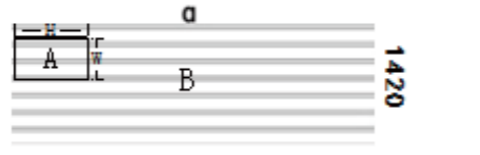

CONFIGURATION TABLES

2022 Configuration Table of Door Panel Patterns of Faula Mobilier Kitchen Cabinets						
Materials	Code	Size of Raw Panel	Pattern Direction	Diagram (A: W*H is the size of door panel. B: the size of raw panel)	Main Pattern	Pattern for Drawer/ Flap Doors
Melamine	BWMA0084	2440*1220*18	Horizontal		Vertical strip	Horizontal strip
	BWMA0083	2440*1220*18	Horizontal		Vertical strip	Horizontal strip
	BWMA0088	2440*1220*18	Horizontal		Vertical strip	Horizontal strip
	BWMA0089	2440*1220*18	Horizontal		Vertical strip	Horizontal strip
	PWMA0157	2440*1220*18	Horizontal		Vertical strip	Horizontal strip
PVC Foil	PWVG0105	0.35*1400	Horizontal		Vertical strip	Horizontal strip
	BWVG0044	0.35*1420	Horizontal		Vertical strip	Horizontal strip
	BWVG0035	0.35*1420	Horizontal		Vertical strip	Horizontal strip

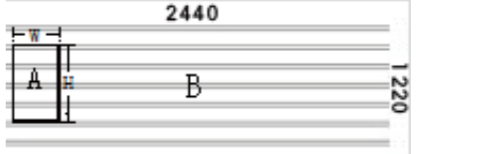
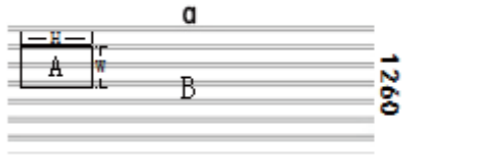
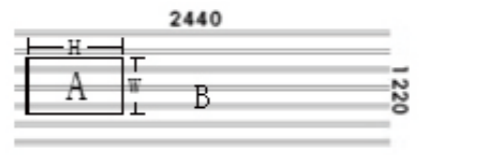
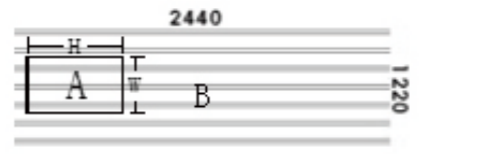
2022 Configuration Table of Door Panel Patterns of Faula Mobilier Kitchen Cabinets						
Materials	Code	Size of Raw Panel	Pattern Direction	Diagram (A: W*H is the size of door panel. B: the size of raw panel)	Main Pattern	Pattern for Drawer/ Flap Doors
UV Lacquer	PWMC0116	18*2440*1220	Horizontal		Horizontal strip	Horizontal strip
	PWMC0115	18*2440*1220	Horizontal		Vertical strip	Horizontal strip
	PWMC0024	18*2440*1220	Horizontal		Vertical strip	Vertical strip
	BWMC0010	18*2440*1220	Horizontal		Vertical strip	Vertical strip



2022 Material-Edge Banding Configuration Table of Faula Mobilier Kitchen Cabinets

Materials	Code	Edge Banding (for door panels)	Edge Banding (for fillers)	Available Thickness of Decorative Panels	
				38mm	50mm
Melamine (18mm)	PWMA0386	PWFP0828	Same as door panels	✓	✗
	PWMA0381	PWFP0824	Same as door panels	✗	✗
	PWMA0387	PWFP0829	Same as door panels	✗	✗
	BWMA0013	BWFP0027(1.2*22mm)	Same as door panels	✓	✗
	BWMA0046	BWFP0067(1.2*22mm)	Same as door panels	✓	✗
	BWMA0047	BWFP0068(1.2*22mm)	Same as door panels	✓	✗
	BWMA0025	BWFP0045(1.2*22mm)	Same as door panels	✓	✗
	BWMA0052	BWFP0076(1.2*22mm)	Same as door panels	✗	✗
	BWMA0056	BWFP0073(1.2*22mm)	Same as door panels	✗	✗
	BWMA0070	BWFP0417(1.2*22mm)	Same as door panels	✗	✓
	PWMA0157	PWFP0449 (1.2*22mm)	Same as door panels	✓	✗
	BWMA0084	BWFP0114(1.2*22mm)	Same as door panels	✗	✗
	PWMA0128	PWFP0388(1.2*23mm)	Same as door panels	✓	✗
	BWMA0086	BWFP0111(1.2*22mm)	Same as door panels	✗	✗
	BWMA0083	BWFP0112(1.2*22mm)	Same as door panels	✓	✗
	BWMA0085	BWFP0110(1.2*22mm)	Same as door panels	✗	✗
	BWMA0104	BWFP0113(1.2*22mm)	Same as door panels	✓	✗
	BWMA0105	BWFP0133(1.2*22mm)	Same as door panels	✗	✗
	BWMA0087	BWFP0034(1.2*22mm)	Same as door panels	✓	✗
	BWMA0071	BWFP0066(1.2*22mm)	Same as door panels	✗	✗
BWMA0074	BWFP0095(1.2*22mm)	Same as door panels	✗	✗	
UV Lacquer (19mm)	PWMC0113	BWFP0822(1.2*22mm)	Same as door panels	✗	✗
	PWMC0114	BWFP0823(1.2*22mm)	Same as door panels	✗	✗
	PWMC0116	BWFP0820(1.2*22mm)	Same as door panels	✓	✗
	PWMC0115	BWFP0827(1.2*22mm)	Same as door panels	✗	✗
	PWMC0019	BWFP0451(1.2*22mm)	Same as door panels	✗	✗
	BWMC0001	BWFP0015(1.2*23mm)	Same as door panels	✗	✗
	BWMC0013	BWFP0090(1.2*23mm)	Same as door panels	✗	✗
	BWMC0009	BWFP0097(1.2*23mm)	Same as door panels	✓	✗
	PWMC0024	BWFP0093(1.2*23mm)	Same as door panels	✗	✗
	BWMC0015	BWFP0106(1.2*23mm)	Same as door panels	✓	✗
	BWMC0019	BWFP0115(1.2*23mm)	Same as door panels	✗	✗
	BWMC0016	BWFP0107(1.2*23mm)	Same as door panels	✗	✗

Notes:
If with special needs, the codes of the needed edge banding should be listed and the difference will be charged according to the price list. If without any prior notice, standard edge banding will be used for all products.

Base Cabinet(metric)

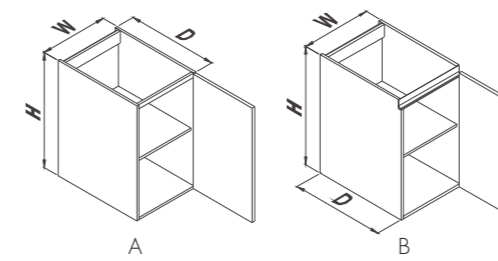

Code
BD07
Description
1 hinged door, 1 movable shelf
Width
150/200/300/350/400/425/450/500/600mm
Depth
560mm
Height
660/720/762mm

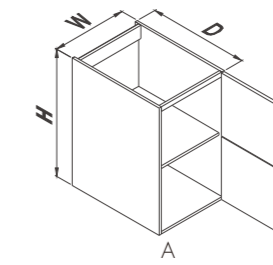

Code
BD08
Description
1 pinned door, 1 movable shelf
Width
400/450/500/600mm
Depth
560mm
Height
660/720/762mm

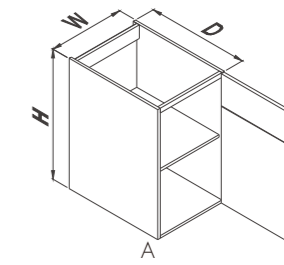

Code
BD09
Description
1 pinned door, 1 movable shelf
Width
400/450/500/600mm
Depth
560mm
Height
660/720/762mm

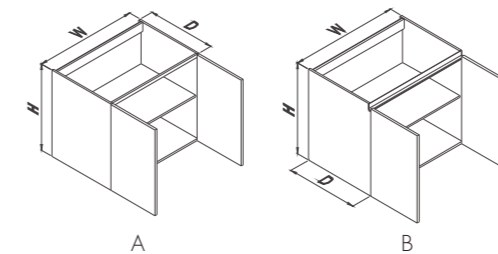

Code
BD10
Description
2 doors, 1 movable shelf
Width
600/700/800/850/900/1000/1200mm
Depth
560mm
Height
660/720/762mm

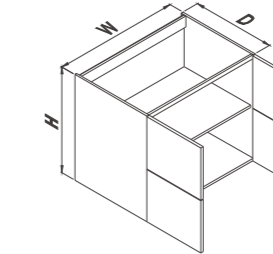

Code
BD11
Description
2 pinned doors, 1 movable shelf
Width
800/900/1000/1200mm
Depth
560mm
Height
660/720/762mm

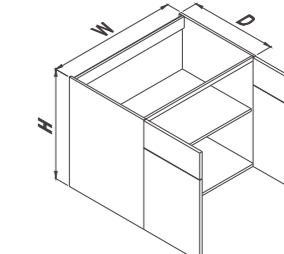

Code
BD12
Description
2 pinned doors, 1 movable shelf
Width
800/900/1000/1200mm
Depth
560mm
Height
660/720/762mm

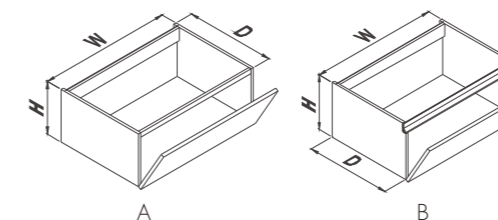

Code
BD30
Description
1 lift-down door
Width
450/500/600/700/800/900mm
Depth
560mm
Height
330/360/381mm

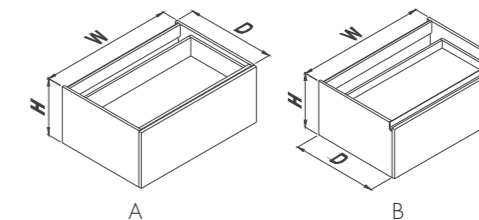

Code
BD31
Description
1 drawer, height: H=330mm
Width
450/500/600/700/800/900/1000mm
Depth
560mm
Height
330/360/381mm

Notes: version A matches handles, however version B matches aluminum bar handles(handleless design).



Base Cabinet(metric)

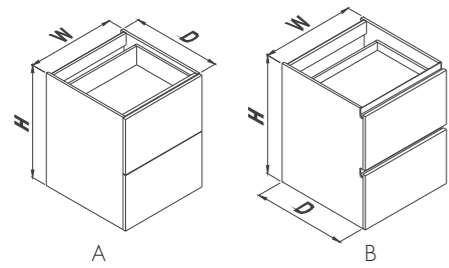

Code
BB09

Description
2 drawer

Width
400/450/500/600/700/800/900/1000mm

Depth
560mm

Height
660/720/762mm

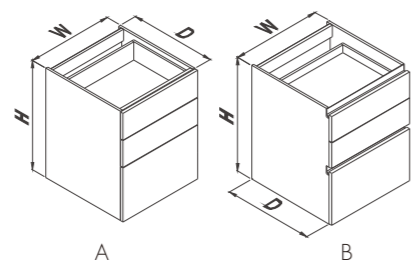

Code
BB10

Description
3 drawer

Width
400/450/500/600/700/800/900/1000mm

Depth
560mm

Height
660/720/762mm

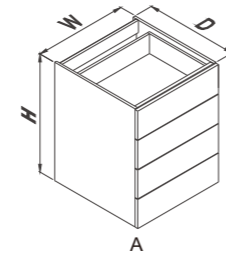

Code
BB11

Description
4 equal drawe

Width
400/450/500/600/700/800/900/1000mm

Depth
560mm

Height
660/720/762mm

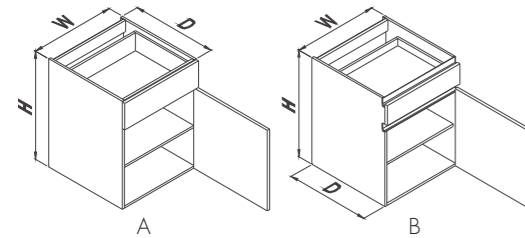

Code
BB12

Description
1 drawer & 1 door, 1 movable shelf

Width
400/450/500/600mm

Depth
560mm

Height
660/720/762mm

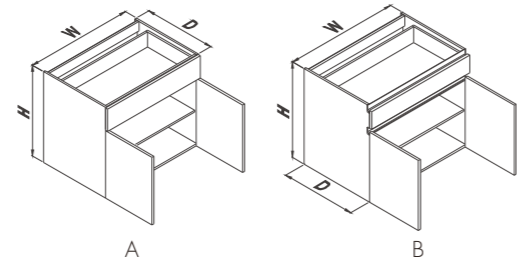

Code
BB13

Description
1 drawer, 2 doors, 1 shelf

Width
600/700/800/900/1000mm

Depth
560mm

Height
660/720/762mm

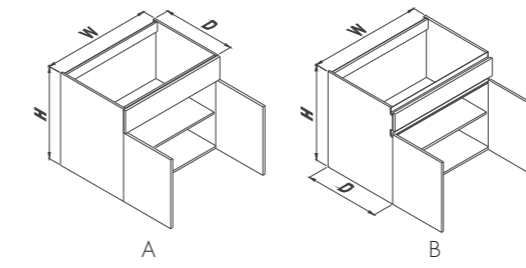

Code
BD14

Description
1 fake drawer & 2 doors, 1 movable shelf

Width
600/700/800/900/1000/1200mm

Depth
560mm

Height
660/720/762mm

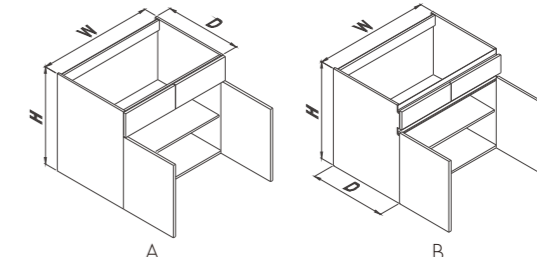

Code
BD15

Description
2 fake drawers & 2 doors, 1 movable shelf

Width
800/900/1000/1200mm

Depth
560mm

Height
660/720/762mm

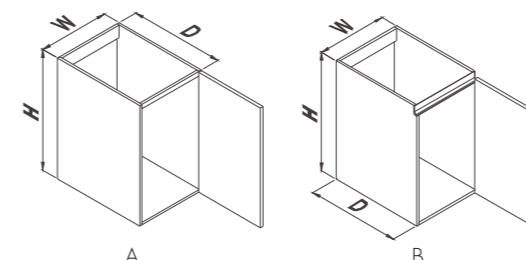

Code
BD16

Description
Sink cabinet, 1 hinged door

Width
600mm

Depth
560mm

Height
660/720/762mm

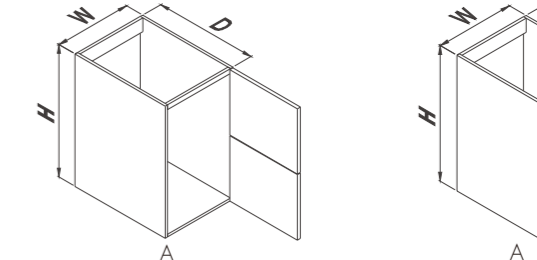

Code
BD17

Description
Sink cabinet, 1 pinned door

Width
600mm

Depth
560mm

Height
660/720/762mm

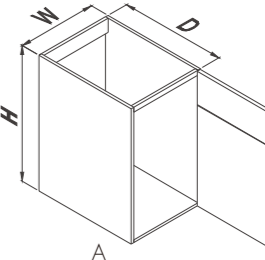

Code
BD18

Description
Sink cabinet, 1 pinned door

Width
600mm

Depth
560mm

Height
660/720/762mm

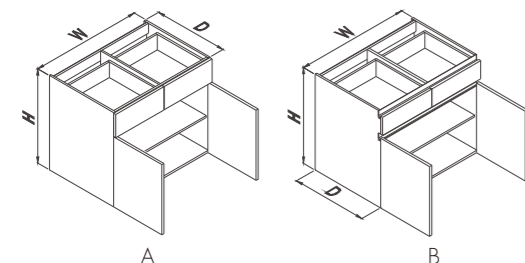

Code
BB14

Description
2 drawers, 2 doors, 1 fixed shelf, 1 movable shelf

Width
800/900/1000/1200mm

Depth
560mm

Height
660/720/762mm

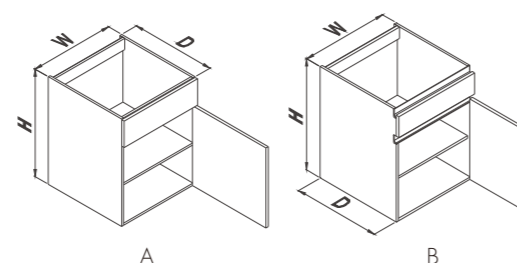

Code
BD13

Description
1 fake drawer & 1 door, 1 movable shelf

Width
400/450/500/600mm

Depth
560mm

Height
660/720/762mm

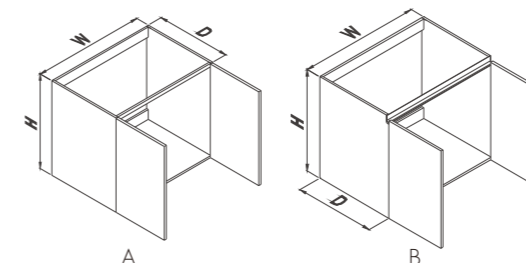

Code
BD19

Description
Sink cabinet, 2 doors

Width
600/700/800/850/900/1000/1200mm

Depth
560mm

Height
660/720/762mm

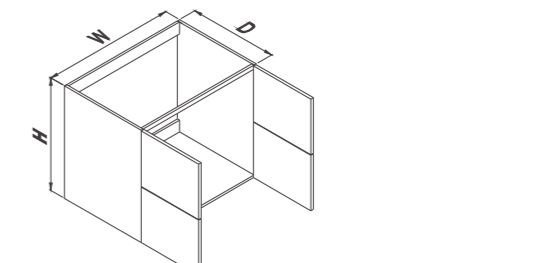

Code
BD20

Description
Sink cabinet, 2 pinned doors

Width
800/900/1000/1200mm

Depth
560mm

Height
660/720/762mm



Base Cabinet(metric)

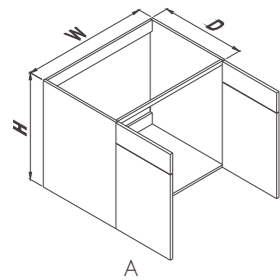

Code
BD21

Description
Sink cabinet, 2 pinned doors

Width
800/900/1000/1200mm

Depth
560mm

Height
660/720/762mm

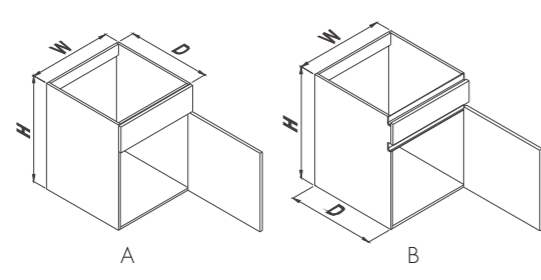

Code
BD22

Description
Sink cabinet, 1 fake drawer, 1 door

Width
600mm

Depth
560mm

Height
660/720/762mm

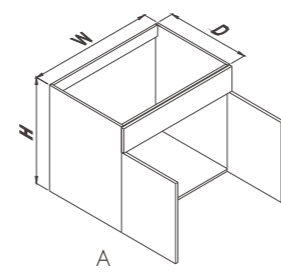

Code
BD23

Description
Sink cabinet, 1 fake drawer, 2 doors

Width
600/700/800/900/1000/1200mm

Depth
560mm

Height
660/720/762mm

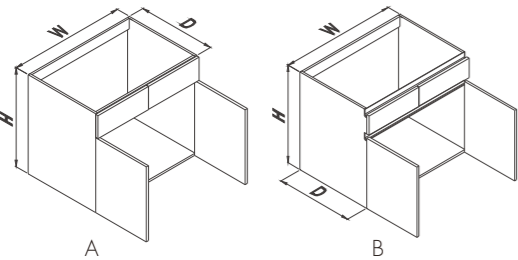

Code
BD24

Description
Sink cabinet, 2 fake drawers, 2 doors

Width
800/900/1000/1200mm

Depth
560mm

Height
660/720/762mm

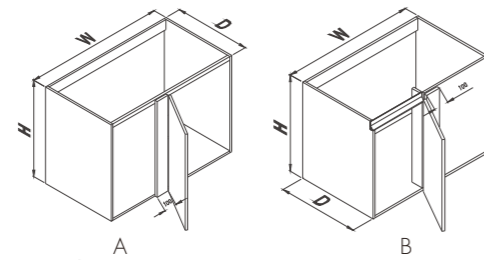

Code
BA07

Description
Sink cabinet, 1 door, standard door width:
W'=400/425/450/500/600mm

Width
600/700/800/900/1000/1200mm

Depth
560mm

Height
660/720/762mm

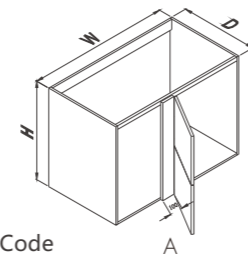

Code
BA08

Description
Corner sink cabinet, 1 pinned door,
standard door width: W'=400/425/
450/500/600mm

Width
600/700/800/900/1000/1200mm

Depth
560mm

Height
660/720/762mm

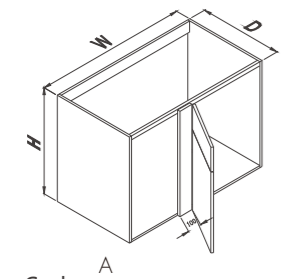

Code
BA09

Description
Corner sink cabinet, 1 pinned door,
standard door width: W'=400/425/
450/500/600mm

Width
600/700/800/900/1000/1200mm

Depth **Height**
560mm 660/720/762mm

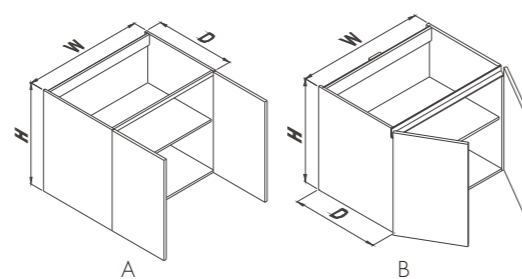

Code
BD25

Description
Stove cabinet, 2 doors, 1 movable shelf

Width
600/700/800/850/900/1000/1200mm

Depth **Height**
560mm 660/720/762mm

Base Cabinet(metric)

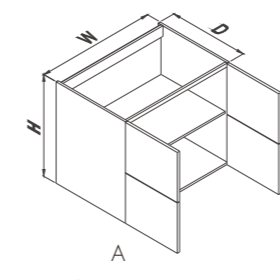

Code
BD26

Description
Stove cabinet, 2 pinned doors,
1 movable shelf

Width
800/900/1000/1200mm

Depth
560mm

Height
660/720/762mm

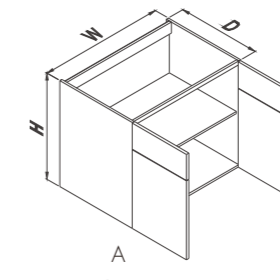

Code
BD27

Description
Stove cabinet, 2 pinned doors,
1 movable shelf

Width
800/900/1000/1200mm

Depth
560mm

Height
660/720/762mm

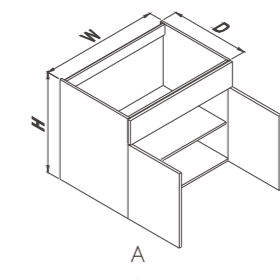

Code
BD28

Description
Stove cabinet, 1 fake drawer, 2 doors,
1 movable shelf

Width
600/700/800/900/1000mm

Depth
560mm

Height
660/720/762mm

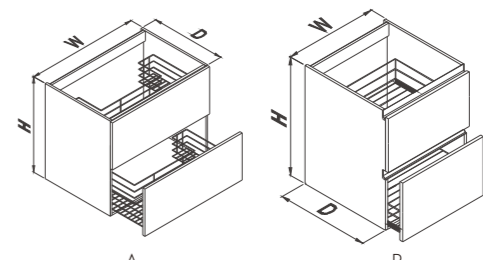
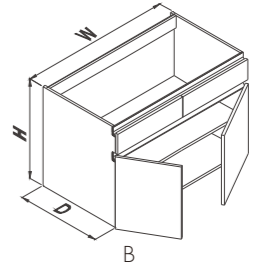

Code
BD29

Description
Stove cabinet, 2 fake drawer, 2 doors,
1 movable shelf

Width
800/900/1000/1200mm

Depth
560mm

Height
660/720/762mm

Code
BE25

Description
Stove cabinet, 2 pull-outs

Width
700/800/900/1000mm

Depth
560mm

Height
660/720/762mm

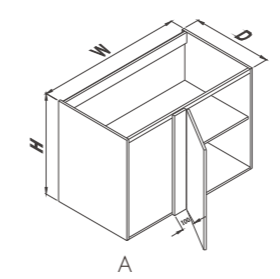

Code
BA13

Description
Corner base cabinet, 1 door, 1 movable shelf,
standard door width: W'=150/200/300/
350/400/425/450/500/600mm

Width
600/700/800/900/1000/1200mm

Depth **Height**
560mm 660/720/762mm

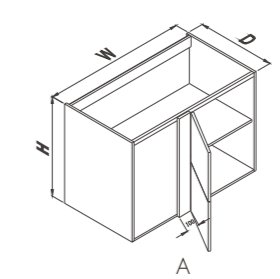

Code
BA14

Description
Corner base cabinet, 1 pinned door,
1 movable shelf, standard door width:
W'=400/425/450/500/600mm

Width
600/700/800/900/1000/1200mm

Depth **Height**
560mm 660/720/762mm

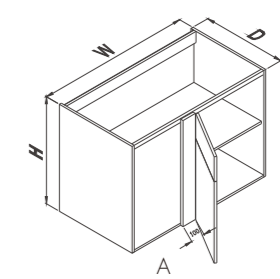

Code
BA15

Description
Corner base cabinet, 1 pinned door,
1 movable shelf, standard door width:
W'=400/425/450/500/600mm

Width
600/700/800/900/1000/1200mm

Depth **Height**
560mm 660/720/762mm



Base Cabinet(metric)

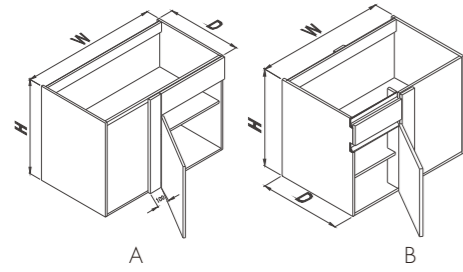

Code
BA19

Description
Corner base cabinet, 1 fake drawer, 1 door,
1 movable shelf, standard door width:
W=400/425/450/500/600mm

Width
600/700/800/900/1000/1200mm

Depth **Height**
560mm 660/720/762mm

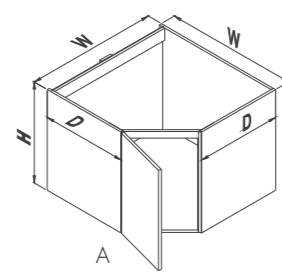

Code
BA22

Description
Charmfer base cabinet, 1 door,
1 movable shelf, standard cabinet
size: door thickness < 22, W=863,
D=560, door thickness=22, W=887,
D=560, door panel width is 400mm

Width **Depth** **Height**
863/867mm 560mm 660/720/762mm

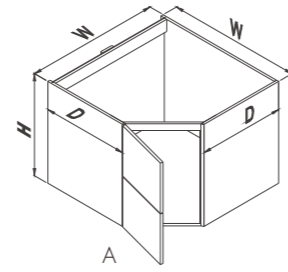

Code
BA23

Description
Charmfer base cabinet, 1 pinned door,
1 movable shelf, standard cabinet size:
door thickness < 22, W=863, D=560,
door thickness=22, W=887, D=560,
door panel width is 400mm

Width **Depth** **Height**
863/867mm 560mm 660/720/762mm

Base Cabinet(metric)

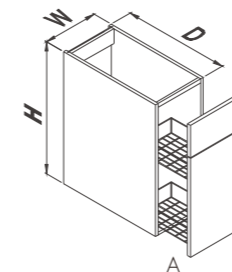

Code
BE27

Description
1 pinned front

Width
400/450/500mm

Depth
560mm

Height
660/720/762mm

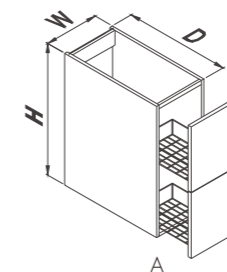

Code
BE28

Description
1 pinned front

Width
400/450/500mm

Depth
560mm

Height
660/720/762mm

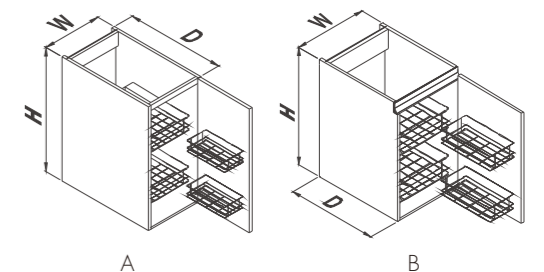

Code
BE29

Description
1 tandem pull-out, 1 door

Width
350/450/600mm

Depth
560mm

Height
660/720/762mm

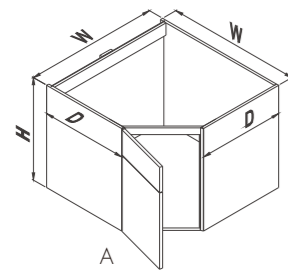

Code
BA24

Description
Charmfer base cabinet, 1 pinned door,
1 movable shelf, standard cabinet size:
door thickness < 22, W=863, D=560,
door thickness=22, W=887, D=560,
door panel width is 400mm

Width **Depth** **Height**
863/867mm 560mm 660/720/762mm

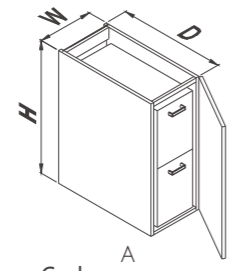

Code
BM01

Description
Rice bin, 1 door

Width
300/450mm

Depth
560mm

Height
660/720/762mm

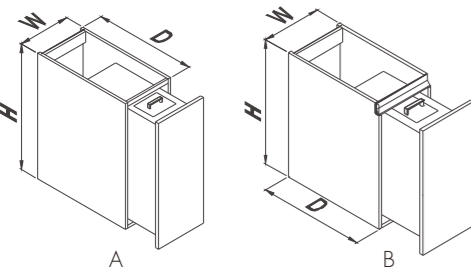
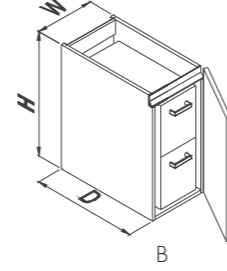

Code
BM02

Description
Rice bin, 1 pinned front

Width
200/300mm

Depth
560mm

Height
660/720/762mm

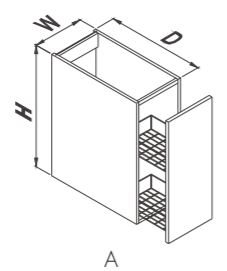

Code
BE26

Description
1 front

Width
150/200/300/350/400/450/500mm

Depth
560mm

Height
660/720/762mm

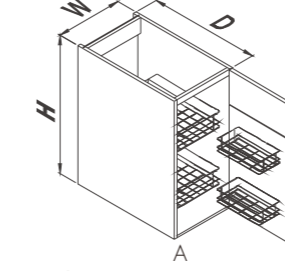
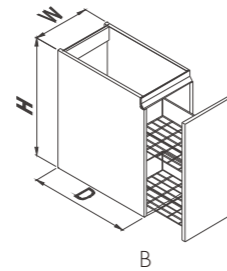

Code
BE30

Description
1 tandem pull-out, 1 pinned door

Width
450/600mm

Depth
560mm

Height
660/720/762mm

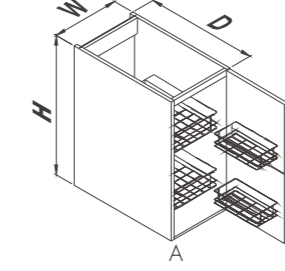

Code
BE31

Description
1 tandem pull-out, 1 pinned door

Width
450/600mm

Depth
560mm

Height
660/720/762mm

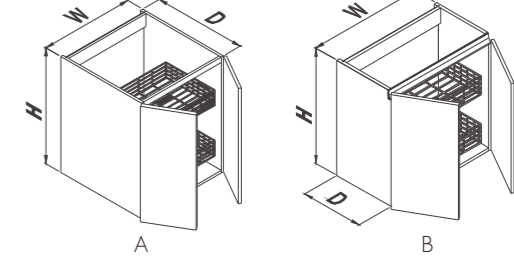

Code
BE32

Description
2 doors

Width
600/700/800/900/1000mm

Depth
560mm

Height
660/720/762mm

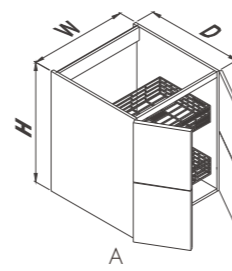

Code
BE33

Description
2 pinned doors

Width
800/900/1000mm

Depth
560mm

Height
660/720/762mm

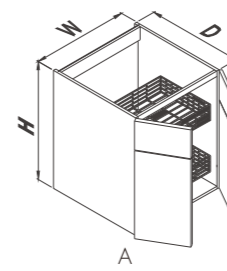

Code
BE34

Description
2 pinned doors

Width
800/900/1000mm

Depth
560mm

Height
660/720/762mm

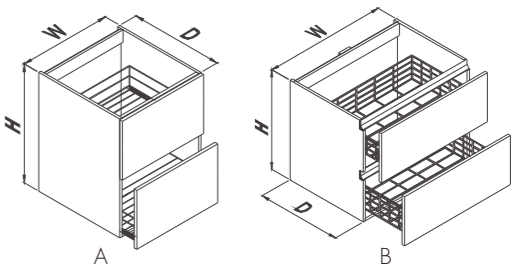

Code
BE35

Description
2 pull-outs

Width
600/700/800/900/1000mm

Depth
560mm

Height
660/720/762mm



Base Cabinet(metric)

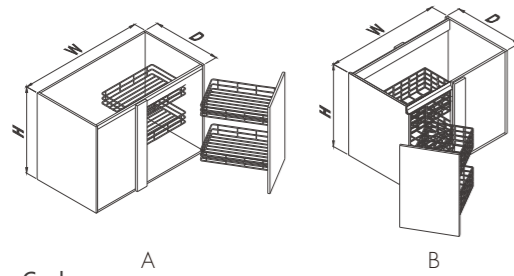

Code
BE36

Description
1 pull-out, 1 door, standard door width:
W'=400/450mm

Width
900/1000mm

Depth
560mm

Height
660/720/762mm

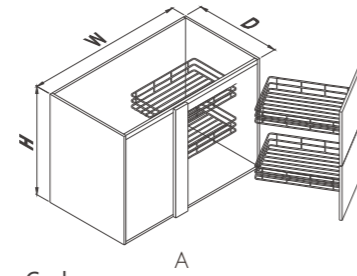

Code
BE37

Description
1 pull-out, 1 pinned door,
standard door width: W'=400/450mm

Width
900/1000mm

Depth
560mm

Height
660/720/762mm

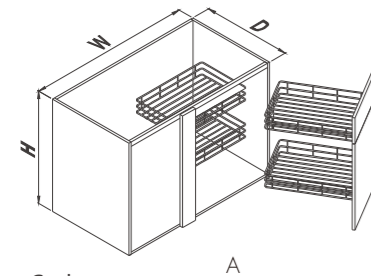

Code
BE38

Description
1 pull-out, 1 pinned door,
standard door width: W'=400/450mm

Width
900/1000mm

Depth **Height**
560mm 660/720/762mm

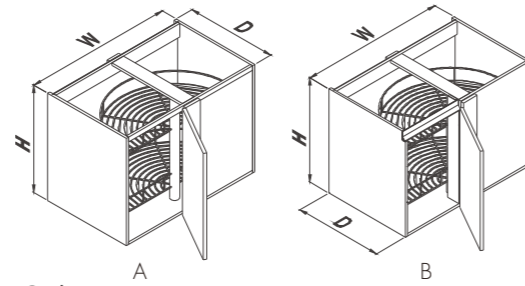

Code
BE39

Description
1 door, 1 rotation basket, standard door width:
W'=450/500/600mm. note: rotation basket
just suitable for 450mm width door panel

Width
900/1000mm

Depth **Height**
560mm 660/720/762mm

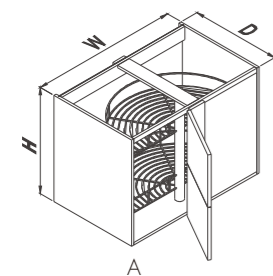

Code
BE40

Description
1 pinned door, 1 rotation basket, standard door
width: W'=450/500/600mm. note: rotation basket
just suitable for 450mm width door panel

Width
900/1000mm

Depth **Height**
560mm 660/720/762mm

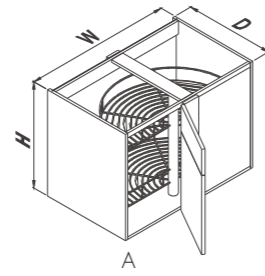

Code
BE41

Description
1 pinned door, 1 rotation basket, standard door
width: W'=450/500/600mm. note: rotation basket
just suitable for 450mm width door panel

Width
900/1000mm

Depth **Height**
560mm 660/720/762mm

Base Cabinet(metric)

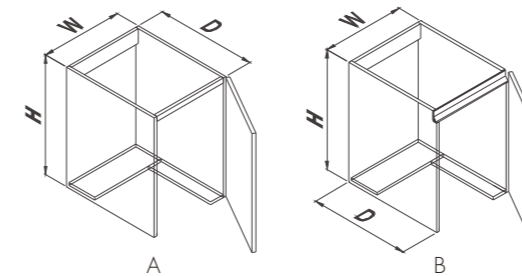

Code
BE42

Description
Gas cylinder cabinet, 1 door, 1 trailer

Width
400/450/500/600mm

Depth
560mm

Height
660/720/762mm

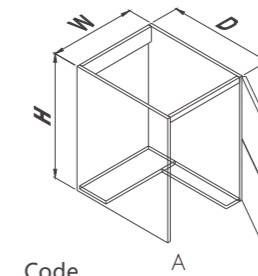

Code
BE43

Description
Gas cylinder cabinet, 1 pinned
door, 1 trailer

Width
400/450/500/600mm

Depth
560mm

Height
660/720/762mm

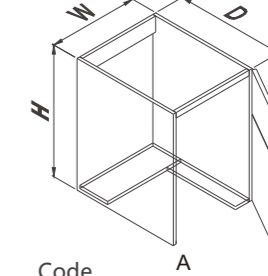

Code
BE44

Description
Gas cylinder cabinet, 1 pinned
door, 1 trailer

Width
400/450/500/600mm

Depth
560mm

Height
660/720/762mm

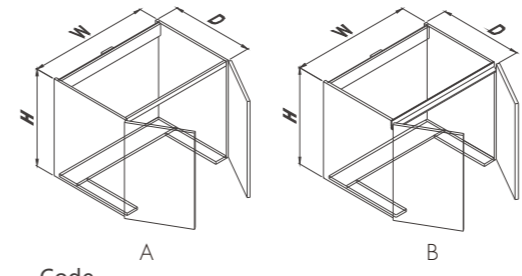

Code
BE45

Description
Gas cylinder cabinet, 2 doors, 1 trailer

Width
400/450/500/600mm

Depth
560mm

Height
660/720/762mm

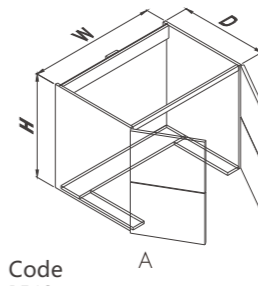

Code
BE46

Description
Gas cylinder cabinet, 2 pinned
doors, 1 trailer

Width
800/900/1000/1200mm

Depth
560mm

Height
660/720/762mm

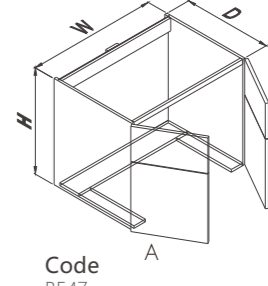

Code
BE47

Description
Gas cylinder cabinet, 2 pinned
doors, 1 trailer

Width
800/900/1000/1200mm

Depth
560mm

Height
660/720/762mm

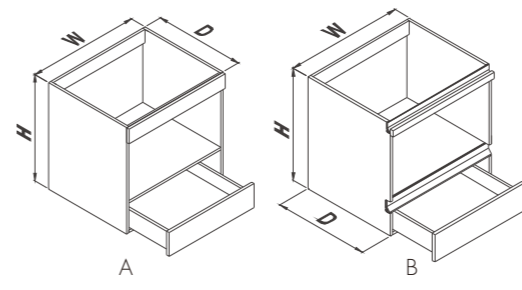

Code
BE48

Description
1 microwave oven, 1 filler, 1 fixed shelf,
1 drawer, drawer height: 162mm/177mm

Width
600mm

Depth **Height**
560mm 660/720/762mm

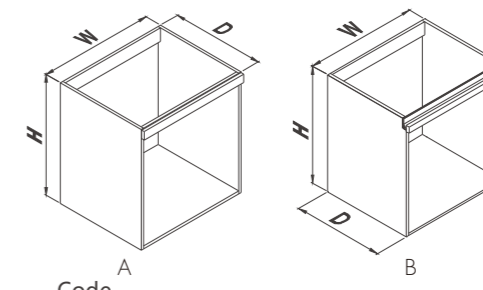

Code
BE49

Description
1 oven, net height: 590, 1 filler

Width
600mm

Depth
560mm

Height
660/720/762mm



Base Cabinet(metric)

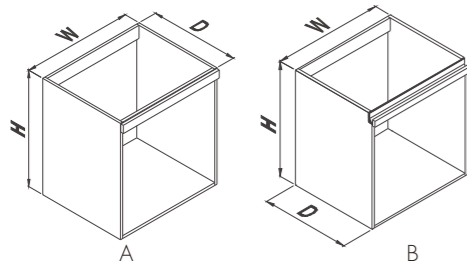

Code
BE53

Description
1 dishwasher, 1 filler

Width
600mm

Depth
560mm

Height
660/720/762mm

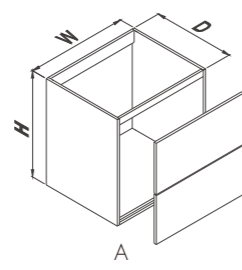

Code
BE50

Description
1 sterilizer, 2 fake drawers

Width
600mm

Depth
560mm

Height
660/720/762mm

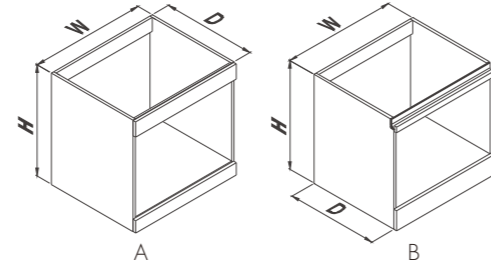

Code
BE51

Description
1 oven, net height: 450, 1 fixed shelf, 2 fillers

Width
600mm

Depth
560mm

Height
660/720/762mm

Middle Cabinet(metric)

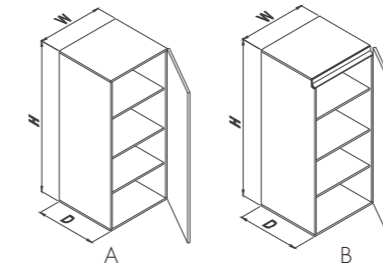

Code
MD03

Description
Single door, 3 shelves

Width
300/450/600mm

Depth
560mm

Height
1380/1440/1482mm

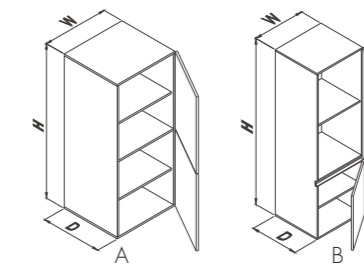

Code
MD04

Description
1 door+1 door, 1 fixed shelf, 2 movable shelves, upper door: H1=720mm, lower door: H2=660/720/762mm

Width
300/450/600mm

Depth **Height**
560mm 1380/1440/1482mm

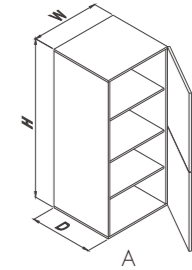

Code
MD05

Description
1 pinned door, 1 fixed shelf, 2 movable shelves, upper door: H1=720mm, lower door: H2=660/720/762mm

Width
300/450/600mm

Depth **Height**
560mm 1380/1440/1482mm

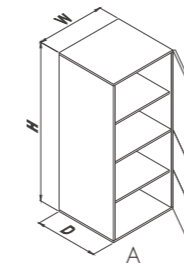

Code
MD06

Description
1 door +1 pinned door, 1 fixed shelf, 2 movable shelves, upper door: H=720mm, lower door:H2=330/360/381mm*2

Width
450/600mm

Depth **Height**
560mm 1380/1440/1482mm

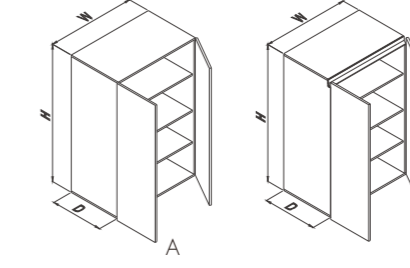

Code
MD07

Description
Double doors, 3 movable shelves

Width
600/900mm

Depth **Height**
560mm 1380/1440/1482mm

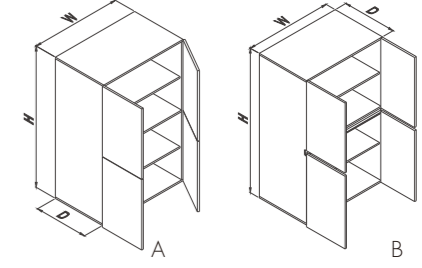

Code
MD08

Description
2 doors+2 doors, 1 fixed shelf, 2 movable shelves, upper door: H=720mm, lower door: H2=660/720/762mm

Width
600/900mm

Depth **Height**
560mm 1380/1440/1482mm

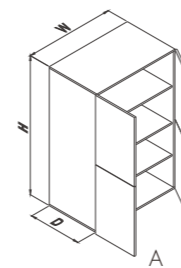

Code
MD09

Description
2 pinned doors, 3 movable shelves, 2 movable shelves, upper door: H=720mm, lower door: H2=660/720/762mm

Width
600/900mm

Depth **Height**
560mm 1380/1440/1482mm

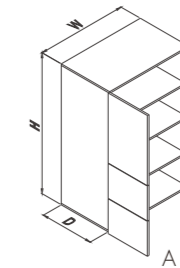

Code
MD10

Description
2 doors, 2 pinned doors, 1 fixed shelf, 2 movable shelves, upper door:H=720mm, lower door:H2=330/360/381mm*2

Width
900mm

Depth **Height**
560mm 1380/1440/1482mm



Middle Cabinet(metric)

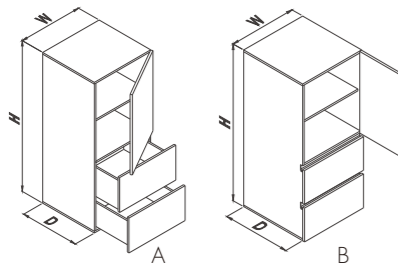

Code
MB01

Description
1 door & 2 drawers, 1 fixed shelf,
1 movable shelf, 2 drawer fronts,
upper door: H=720mm

Width
450/600mm

Depth **Height**
560mm 1380/1440/1482mm

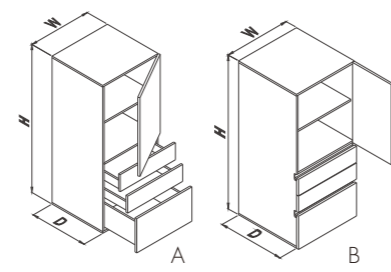

Code
MB02

Description
1 door & 3 drawers, 1 fixed shelf,
2 movable shelves, 3 drawer fronts,
upper door: H=720mm

Width
450/600mm

Depth **Height**
560mm 1380/1440/1482mm

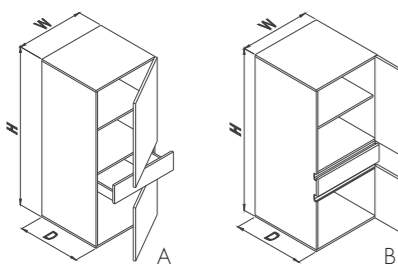

Code
MB03

Description
1 door & 1 drawer & 1 door, 1 fixed shelf,
1 movable shelf, 1 drawer front, upper door:
H=720mm

Width
450/600mm

Depth **Height**
560mm 1380/1440/1482mm

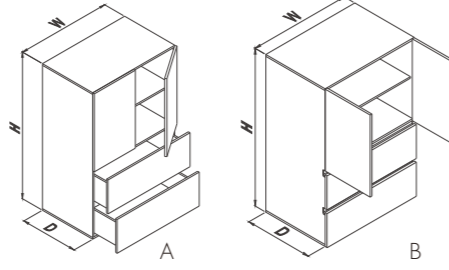

Code
MB04

Description
2 doors & 2 drawers, 1 fixed shelf,
1 movable shelf, 2 drawer fronts,
upper door: H=720mm

Width
600/900mm

Depth **Height**
560mm 1380/1440/1482mm

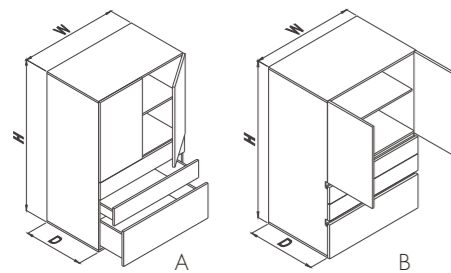

Code
MB05

Description
2 doors & 3 drawers, 1 fixed shelf,
1 movable shelf, 3 drawers,
upper door: H=720mm

Width
600/900mm

Depth **Height**
560mm 1380/1440/1482mm

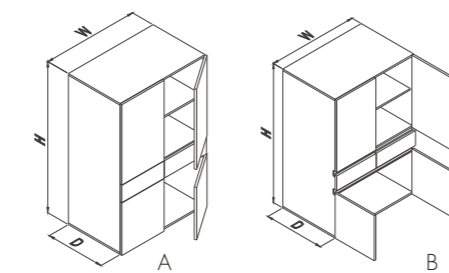

Code
MB06

Description
2 doors & 2 drawers & 2 doors, 1 fixed shelf,
1 movable shelf, 2 drawer fronts, upper door:
H=720mm

Width
900mm

Depth **Height**
560mm 1380/1440/1482mm

Middle Cabinet(metric)

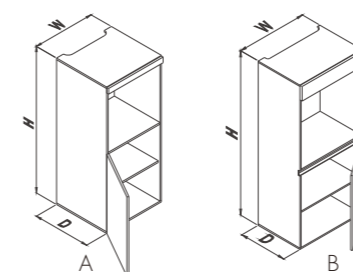

Code
ME07

Description
filler & oven & 1 door, 1 fixed shelf,
1 movable shelf, lower door:
H=660/720/762mm

Width
600mm

Depth **Height**
560mm 1380/1440/1482mm

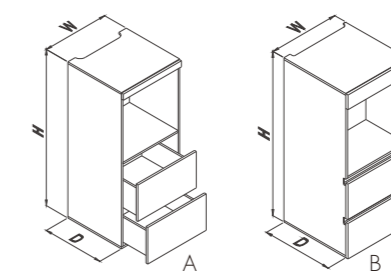

Code
ME08

Description
filler & oven & 2 drawers,
1 fixed shelf, 2 drawer fronts

Width
600mm

Depth **Height**
560mm 1380/1440/1482mm

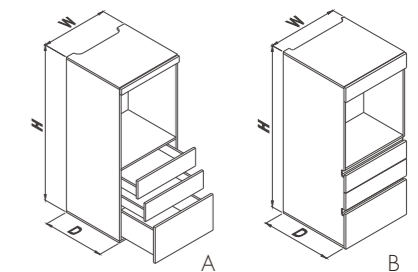

Code
ME09

Description
filler & oven & 3 drawers, 1 fixed shelf,
3 drawer fronts, thick back panel

Width
600mm

Depth **Height**
560mm 1380/1440/1482mm

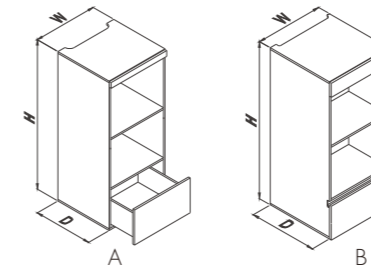

Code
ME10

Description
filler & 2 ovens & 1 drawer, 2 fixed shelves,
1 drawer front, drawer height: H=330/360/381mm

Width
600mm

Depth **Height**
560mm 1380/1440/1482mm

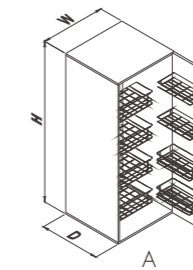

Code
ME11

Description
1 door, 1 tandem pull-out
OP6K060M-1

Width
450/600mm

Depth **Height**
560mm 1380/1440/1482mm

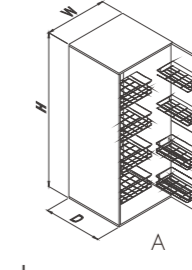

Code
ME12

Description
1 pinned door, 1 tandem pull-out
OP6K060M-1, lower height:
H=660/720/762mm

Width
450/600mm

Depth **Height**
560mm 1380/1440/1482mm

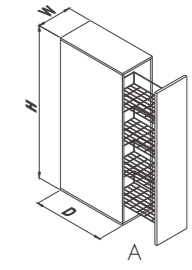

Code
ME13

Description
1 tandem pull-out,
LG030M-1

Width
300mm

Depth **Height**
560mm 1380/1440/1482mm

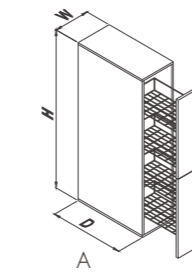

Code
ME14

Description
1 pinned front, 1 tandem
pull-out LG030M-1, lower
height: H=660/720/762mm

Width
300mm

Depth **Height**
560mm 1380/1440/1482mm

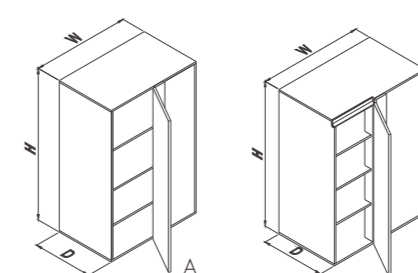

Code
MA01

Description
Corner high cabinet, 1 door & 1 door,
3 movable shelves, standard door width:
W=300/450/600mm

Width
600/700/800/900mm

Depth **Height**
560mm 1380/1440/1482mm

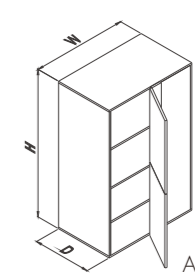

Code
MA02

Description
Corner high cabinet, 2 pinned doors,
3 movable shelves, standard door width:
W=300/450/600mm upper door: H1=720mm,
lower door: H2=660/720/762mm

Width
600/700/800/900mm

Depth **Height**
560mm 1380/1440/1482mm



High Cabinet(metric)

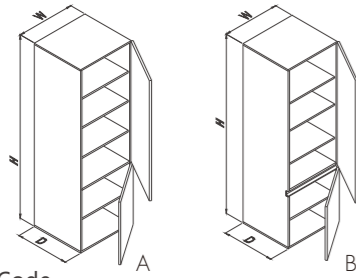

Code
TD07

Description
1 door & 1 door, 1 fixed shelf, 4 movable shelves, lower door: H=660/720/762mm

Width
300/450/600mm

Depth
560mm

Height
2100/2160/2202/2280/2340mm

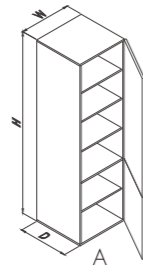

Code
TD08

Description
1 door & 1 door, 1 fixed shelf, 4 movable shelves, lower door: H=660/720/762mm

Width
300/450/600mm

Depth
560mm

Height
2100/2160/2202/2280/2340mm

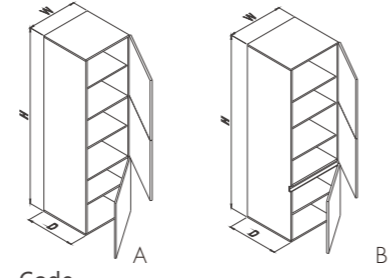

Code
TD09

Description
1 pinned door & 1 door, 1 fixed shelf, 4 movable shelves, upper door: H1=720/900mm, middle door:H2=720mm, lower door: H3=660/720/762mm

Width **Depth**
300/450/600mm 560mm

Height
2100/2160/2202/2280/2340mm

High Cabinet(metric)

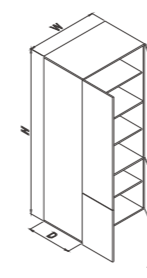

Code
TD15

Description
2 pinned doors, 1 fixed shelf, lower door: H=660/720/762mm

Width **Depth**
600/900mm 560mm

Height
2100/2160/2202/2280/2340mm

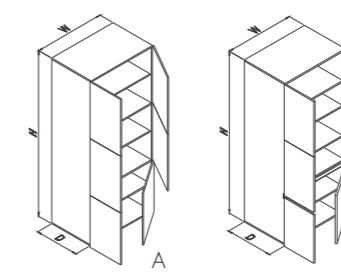

Code
TD16

Description
2 pinned doors & 2 doors, 1 fixed shelf, 4 movable shelves, upper door: H1=720/900mm, middle door: H2=720mm, lower door: H3=660/720/762mm

Width **Depth**
600/900mm 560mm

Height
2100/2160/2202/2280/2340mm

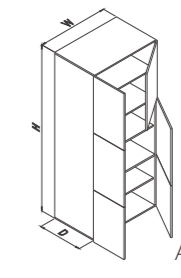

Code
TD17

Description
2 doors & 2 pinned doors, 1 fixed shelf, 4 movable shelves, upper door: H1=720/900mm, middle door: H2=720mm, lower door: H3=660/720/762mm

Width **Depth**
600/900mm 560mm

Height
2100/2160/2202/2280/2340mm

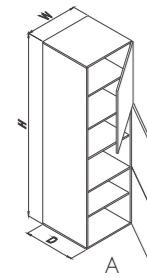

Code
TD10

Description
1 door & 1 pinned door, 1 fixed shelf, 4 movable shelves, upper door: H1=720/900mm, middle door: H2=720mm, lower door: H3=660/720/762mm

Width **Depth**
300/450/600mm 560mm

Height
2100/2160/2202/2280/2340mm

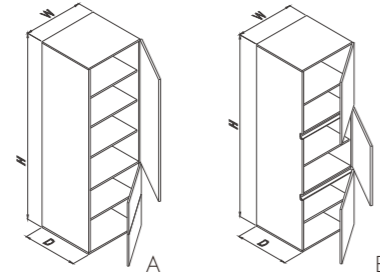

Code
TD11

Description
1 door & 1 pinned door, 1 fixed shelf, 4 movable shelves, lower door: H=660/720/762mm

Width **Depth**
450/600mm 560mm

Height
2100/2160/2202/2280/2340mm

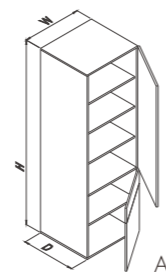

Code
TD12

Description
1 door & 1 pinned door, 1 fixed shelf, 4 movable shelves, lower door: H=660/720/762mm

Width **Depth**
450/600mm 560mm

Height
2100/2160/2202/2280/2340mm

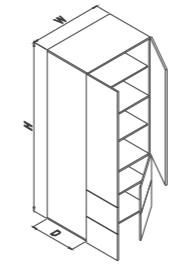

Code
TD18

Description
2 doors & 2 pinned doors, 1 fixed shelf, 4 movable shelves, lower door: H=660/720/762mm

Width **Depth**
600/900mm 560mm

Height
2100/2160/2202/2280/2340mm

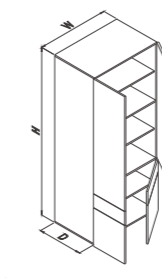

Code
TD19

Description
2 doors & 2 pinned doors, 1 fixed shelf, 4 movable shelves, lower door: H=660/720/762mm

Width **Depth**
600/900mm 560mm

Height
2100/2160/2202/2280/2340mm

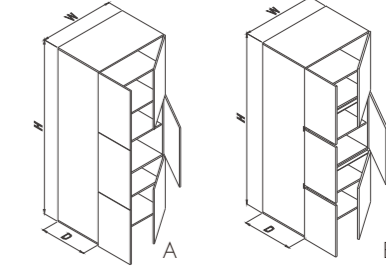

Code
TD20

Description
2 doors & 2 doors & 2 door, 2 fixed shelves, 3 movable shelves, upper door:H1=720/900mm, middle door: H2=720mm, lower door: H3=660/720/762mm

Width **Depth**
600/900mm 560mm

Height
2100/2160/2202/2280/2340mm

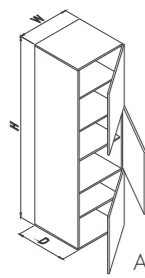

Code
TD13

Description
1 door & 1 door & 1 door, 2 fixed shelves, 3 movable shelves, upper door: H1=720/900mm, middle door: H2=720mm, lower door: H3=660/720/762mm

Width **Depth**
300/450/600mm 560mm

Height
2100/2160/2202/2280/2340mm

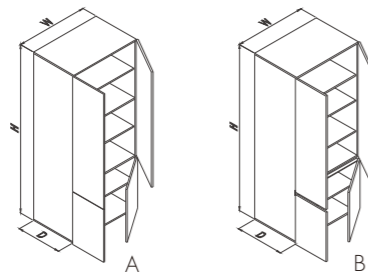

Code
TD14

Description
2 doors & 2 doors, 1 fixed shelf, 4 movable shelves, lower door: H=660/720/762mm

Width **Depth**
600/900mm 560mm

Height
2100/2160/2202/2280/2340mm

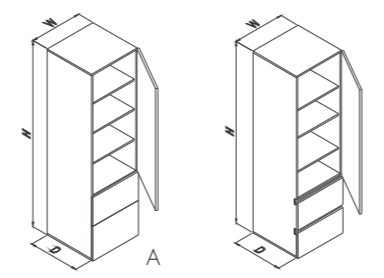

Code
TB01

Description
1 door & 2 drawers, 1 fixed shelf, 3 movable shelves, 2 drawer fronts

Width **Depth**
450/600mm 560mm

Height
2100/2160/2202/2280/2340mm



High Cabinet(metric)

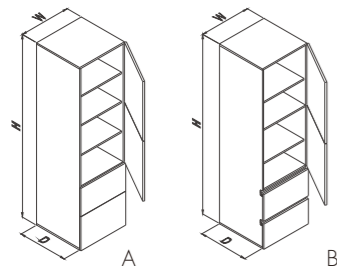

Code
TB04

Description
1 pinned door & 2 drawers, 1 fixed shelf, 3 movable shelves, 2 drawer fronts, upper door: H1=720/900mm, middle door: H2=720mm

Width **Depth**
450/600mm 560mm

Height
2100/2160/2202/2280/2340mm

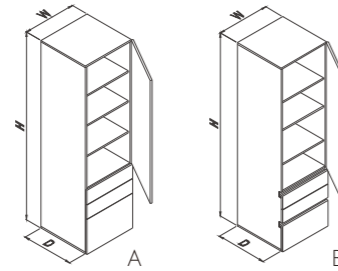

Code
TB02

Description
1 door & 3 drawers, 1 fixed shelf, 3 movable shelves, 3 drawer fronts

Width
450/600mm

Depth
560mm

Height
2100/2160/2202/2280/2340mm

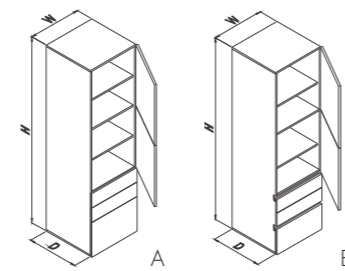

Code
TB05

Description
1 pinned door & 3 drawers, 1 fixed shelf, 3 movable shelves, 3 drawer fronts, upper door: H1=720mm, middle door: H2=720mm

Width **Depth**
450/600mm 560mm

Height
2100/2160/2202/2280/2340mm

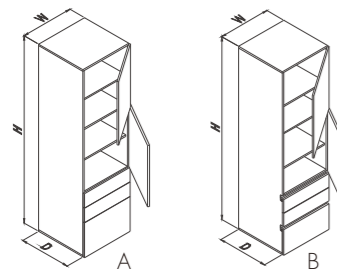

Code
TB06

Description
1 door & 1 door & 3 drawers, 2 fixed shelves, 2 movable shelves, 3 drawer fronts, upper door: H1=720/900mm, middle door: H2=720mm

Width **Depth**
450/600mm 560mm

Height
2100/2160/2202/2280/2340mm

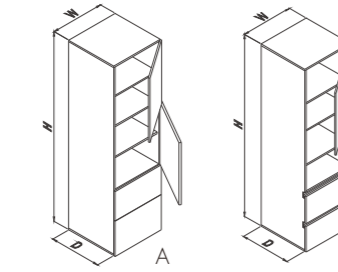

Code
TB03

Description
1 door & 1 door & 2 drawers, 2 fixed shelves, 2 movable shelves, 2 drawer fronts, upper door: H1=720/900mm, middle door: H2=720mm

Width **Depth**
450/600mm 560mm

Height
2100/2160/2202/2280/2340mm

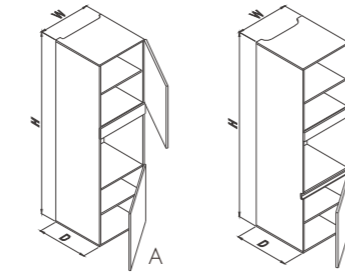

Code
TE24

Description
1 door & 1 filler & oven & 1 door, 3 fixed shelves, 2 movable shelves, upper door: H1=720/900mm, lower door: H2=660/720/762mm

Width **Depth**
600mm 560mm

Height
2100/2160/2202/2280/2340mm

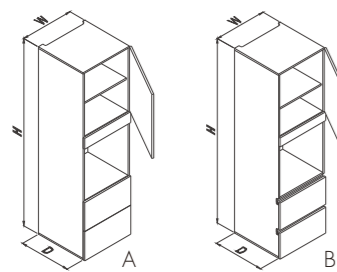

Code
TE26

Description
1 door & 1 filler & oven & 2 drawers, 1 filler, 2 drawer fronts, 2 fixed shelves, 1 movable shelf, upper door: H=720/900mm

Width **Depth**
600mm 560mm

Height
2100/2160/2202/2280/2340mm

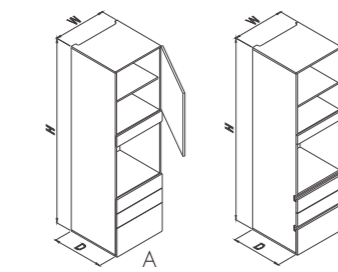

Code
TE27

Description
1 door & 1 filler & oven & 3 drawers, 1 filler, 3 drawer fronts, 2 fixed shelves, 1 movable shelf, upper door: H=720/900mm

Width **Depth**
600mm 560mm

Height
2100/2160/2202/2280/2340mm

High Cabinet(metric)

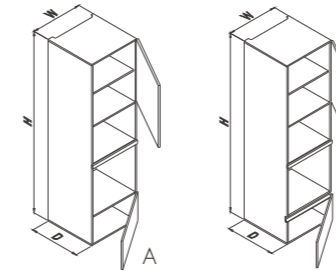

Code
TE28

Description
1 door & oven & filler & oven & 1 door, 2 fillers, 3 fixed shelves, 1 movable shelf, upper door: H1=720/900mm, lower door: H2=330/360/381mm

Width **Depth**
600mm 560mm

Height
2100/2160/2202/2280/2340mm

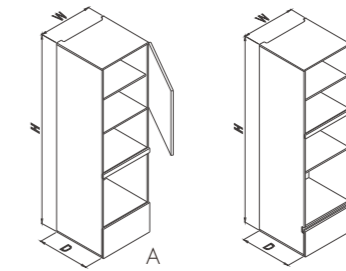

Code
TE30

Description
1 door & oven & filler & oven & 1 drawer, 1 filler, 3 fixed shelves, 1 movable shelf, upper door: H1=720/900mm, lower door: H2=330/360/381mm

Width **Depth**
600mm 560mm

Height
2100/2160/2202/2280/2340mm

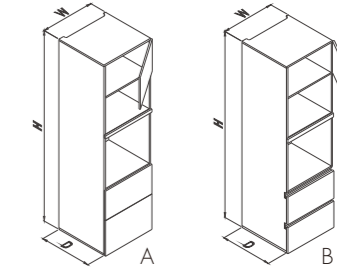

Code
TE31

Description
1 door & oven & filler & oven & 2 drawers, 3 fillers, 3 fixed shelves, upper door: H=360/450mm

Width **Depth**
600mm 560mm

Height
2100/2160/2202/2280/2340mm

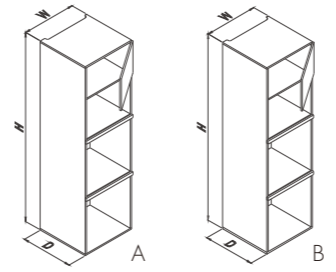

Code
TE32

Description
1 door & oven & filler, 3 fillers, 3 fixed shelves, upper door: H=360/450mm

Width **Depth**
600mm 560mm

Height
2100/2160/2202/2280/2340mm

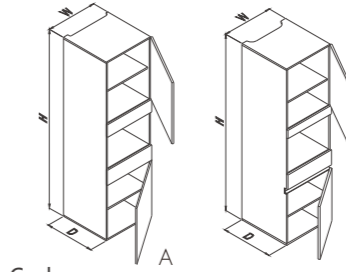

Code
TE25

Description
1 door & filler & oven & 1 drawer & 1 door, 1 filler, 2 fixed shelves, 2 movable shelves, upper door: H1=720/900mm, middle drawer: H2=180mm, lower door: H3=660/720/762mm

Width **Depth**
600mm 560mm

Height
2100/2160/2202/2280/2340mm

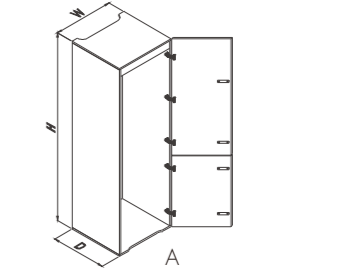

Code
TE33

Description
1 door & 1 door, 1 filler, lower door: H=660/720/762mm

Width **Depth**
600mm 560mm

Height
2100/2160/2202/2280/2340mm

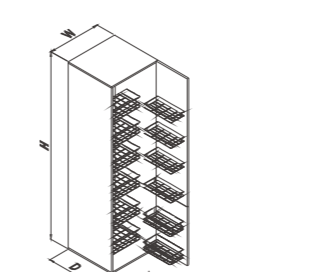

Code
TE35

Description
1 tandem pull-out OP-LK060H-1, lower door: H=660/720/762mm

Width **Depth**
600mm 560mm

Height
2100/2160/2202/2280/2340mm

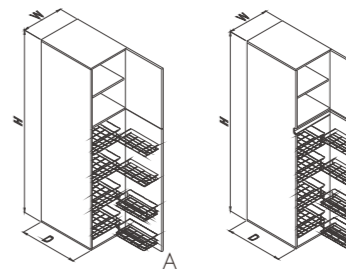

Code
TE36

Description
1 door & 1 tandem pull-out OP-LK060M-1, 1 fixed shelf, 1 movable shelf, upper door: H=720/900mm

Width **Depth**
600mm 560mm

Height
2100/2160/2202/2280/2340mm



High Cabinet(metric)

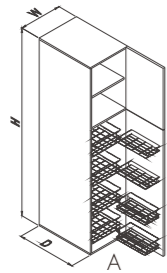

Code
TE37

Description
1 door & 1 tandem pull-out OP-LK060M-1,
1 fixed shelf, 1 movable shelf, upper door:
H=720/900mm

Width **Depth**
600mm 560mm

Height
2100/2160/2202/2280/2340mm

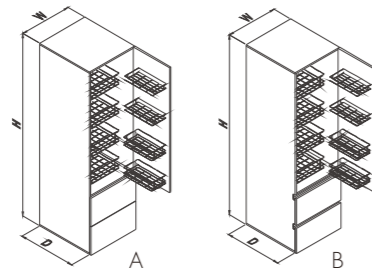

Code
TE38

Description
1 tandem pull-out OP-LK060M-1,
& 2 drawers, 1 fixed shelf

Width **Depth**
600mm 560mm

Height
2100/2160/2202/2280/2340mm

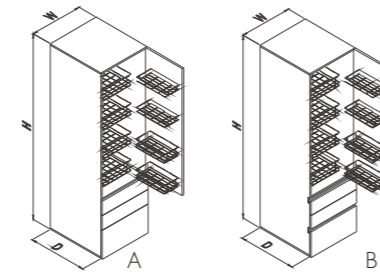

Code
TE39

Description
1 tandem pull-out OP-LK060M-1,
& 3 drawers, 1 fixed shelf

Width **Depth**
600mm 560mm

Height
2100/2160/2202/2280/2340mm

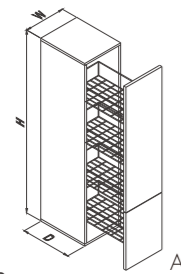

Code
TE42

Description
1 pinned door, 1 tandem pull-out
OP-LK030H-1, lower door:
H=660/720/762mm

Width
300mm

Depth
560mm

Height
2100/2160/2202/2280/2340mm

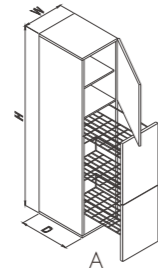

Code
TE43

Description
1 door & 1 pinned door, 1 fixed shelf,
1 movable shelf, 1 tandem pull-out
OP-LK030M-1, upper door: H1=720/900mm,
middle door: H2=720mm, lower door:
H3=660/720/762mm

Width **Depth**
300mm 560mm

Height
2100/2160/2202/2280/2340mm

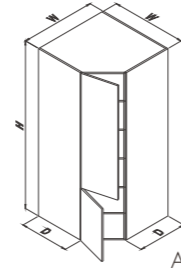

Code
TA06

Description
Charmfer cabinet, 1 door & 1 door,
1 fixed shelf, 4 movable shelves, door width:
W=400, lower door: H=660/720/762mm,
size: door thickness < 22, W1/W2=883 D=580,
door thickness=22, W1/W2=887 D=580

Width **Depth**
863/867mm 560mm

Height
2100/2160/2202/2280/2340mm

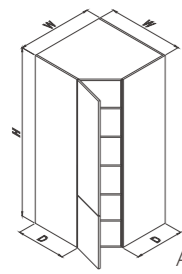

Code
TA07

Description
Charmfer cabinet, 1 pinned door, 1 fixed shelf,
4 movable shelves, door width: W=400,
lower door: H=660/720/762mm,
size: door thickness < 22, W1/W2=883 D=580,
door thickness=22, W1/W2=887 D=580

Width **Depth**
863/867mm 560mm

Height
2100/2160/2202/2280/2340mm

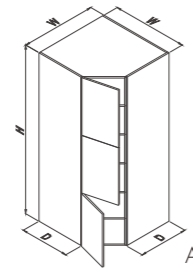

Code
TA08

Description
Charmfer cabinet, 1 pinned door & 1 door,
1 fixed shelf, 4 movable shelves, door width:
W=400, upper door: H1=720/900mm,
middle door: H2=720mm,
lower door: H3=660/720/762mm

Width **Depth**
863/867mm 560mm

Height
2100/2160/2202/2280/2340mm

High Cabinet(metric)

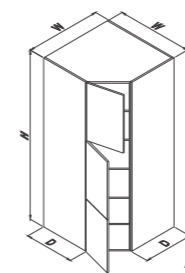

Code
TA09

Description
charmfer cabinet, 1 door &
1 pinned door, 1 fixed shelf,
4 movable shelves, door width: W=400,
upper door: H1=720/900mm,
middle door: H2=720mm,
lower door: H3=660/720/762mm

Width **Depth**
863/867mm 560mm

Height
2100/2160/2202/2280/2340mm

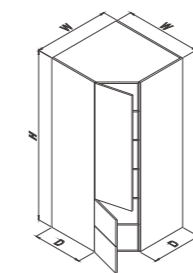

Code
TA10

Description
charmfer cabinet, 1 door & 1 pinned door,
1 fixed shelf, 4 movable shelves, door width:
W=400, lower door: H=660/720/762mm

Width
863/867mm

Depth
560mm

Height
2100/2160/2202/2280/2340mm

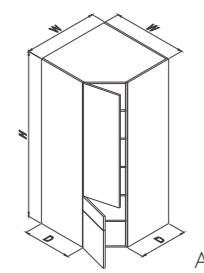

Code
TA11

Description
charmfer cabinet, 1 door & 1 pinned door,
1 fixed shelf, 4 movable shelves, door width:
W=400, lower door: H=660/720/762mm

Width
863/867mm

Depth
560mm

Height
2100/2160/2202/2280/2340mm

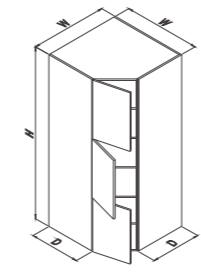

Code
TA12

Description
Charmfer cabinet, 1 door & 1 door & 1 door,
1 fixed shelf, 4 movable shelves, door width:
W=400, upper door: H1=720/900mm,
middle door: H2=720mm, lower door:
H3=660/720/762mm

Width **Depth**
863/867mm 560mm

Height
2100/2160/2202/2280/2340mm

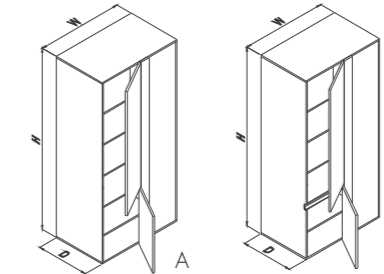

Code
TA05

Description
Corner high cabinet, 1 door & 1 door, 1 fixed shelf,
4 movable shelves, door width: W=400/450/500mm,
lower door: H=660/720/762mm

Width
700/800/900mm

Depth
560mm

Height
2100/2160/2202/2280/2340mm



Wall Cabinet(metric)

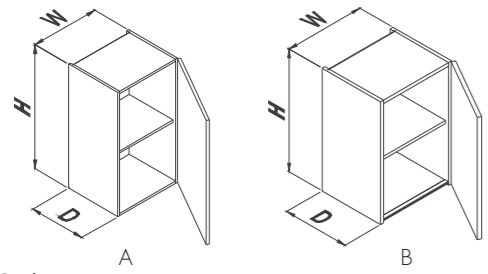

Code
WD04

Description
1 door, 1 movable shelf

Width
150/200/300/350/400/425/450/500/600mm

Depth
330mm

Height
720/900mm

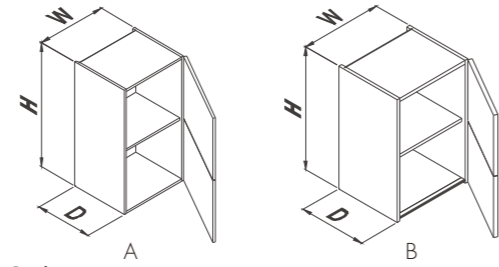

Code
WD05

Description
1 pinned door, 1 movable shelf

Width
400/450/500/600mm

Depth
330mm

Height
720/900mm

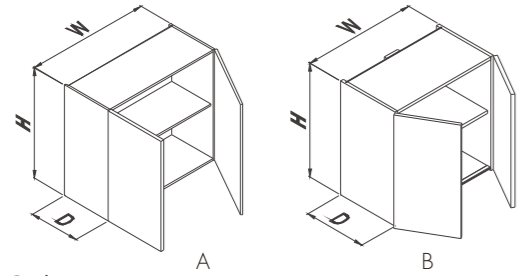

Code
WD06

Description
2 doors, 1 movable shelf

Width
600/700/800/850/900mm

Depth
330mm

Height
720/900mm

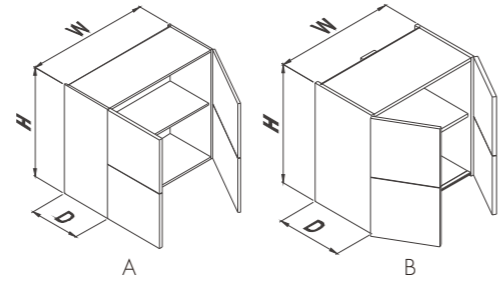

Code
WD07

Description
2 pinned doors, 1 movable shelf

Width
800/900mm

Depth
330mm

Height
720/900mm

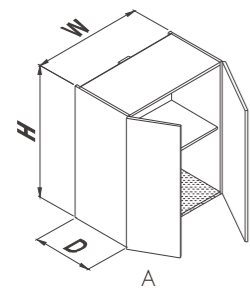

Code
WD08

Description
2 doors, 1 movable shelf,
1 bottom light

Width
600/700/800/900mm

Depth **Height**
330mm 720/900mm

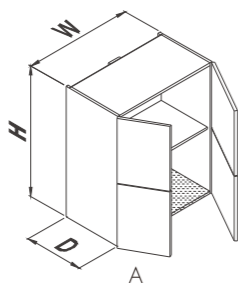

Code
WD09

Description
2 pinned doors, 1 movable shelf,
1 bottom light

Width
800/900mm

Depth **Height**
330mm 720/900mm

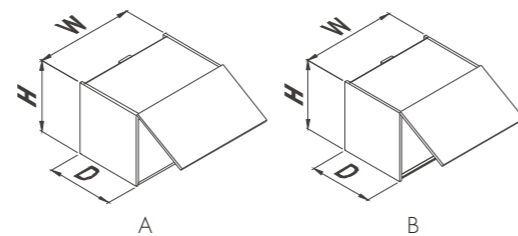

Code
WU06

Description
1 lift-up door, 1 support

Width
400/450/500/600/700/800/900mm

Depth
330mm

Height
360/450/720/900mm

Wall Cabinet(metric)

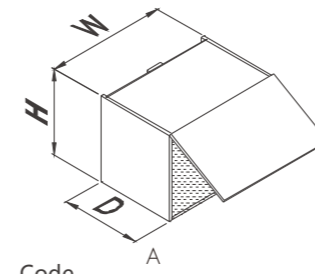

Code
WU07

Description
1 lift-up door, 1 support,
1 bottom light

Width
600/700/800/900mm

Depth
330mm

Height
360/450/720/900mm

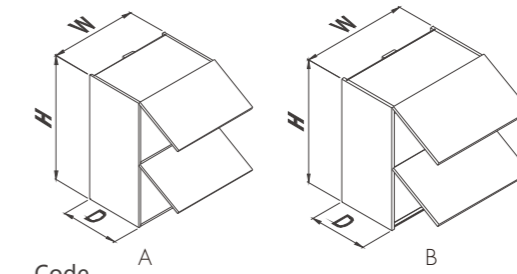

Code
WU08

Description
2 lift-up doors, 4 supports, 1 fixed shelf

Width
400/450/500/600/700/800/900mm

Depth
330mm

Height
720/900mm

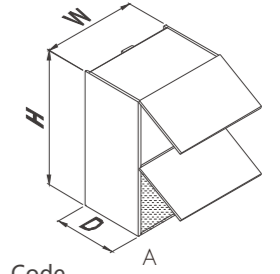

Code
WU09

Description
2 lift-up doors, 4 supports,
1 fixed shelf, 1 bottom light

Width
600/700/800/900mm

Depth
330mm

Height
720/900mm

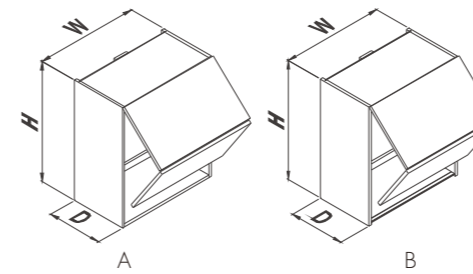

Code
WU11

Description
1 folding door, 1 support, 1 shelf

Width
600/700/800/900mm

Depth
330mm

Height
720/900mm

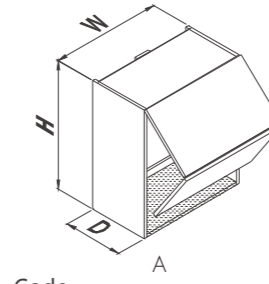

Code
WU12

Description
1 folding door, 1 support,
1 shelf, 1 bottom light

Width
600/700/800/900mm

Depth
330mm

Height
720/900mm

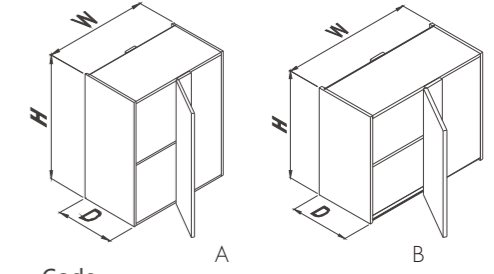

Code
WA08

Description
Corner wall unit, 1 door, 1 shelf, standard door
width: W=300/350/400/450/500/600mm

Width
500/600/700/800/900mm

Depth
330mm

Height
360/450/720/900mm

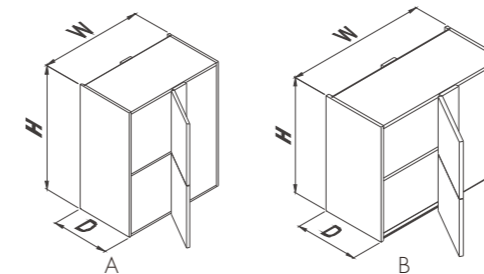

Code
WA09

Description
Corner wall unit, 1 pinned door, 1 shelf, standard
door width: W=400/450/500/600mm

Width
800/900/1000/1200mm

Depth
330mm

Height
720/900mm



Wall Cabinet(metric)

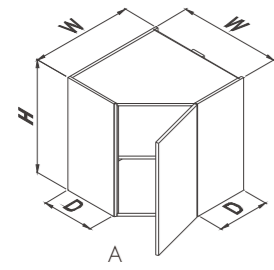

Code
WA12

Description

Corner wall unit, 1 door, 1 shelf, standard cabinet size: door thickness < 22, W=633, D=330, door thickness=22, W=637, D=330, door panel width is 400mm

Width 633/637mm
Depth 330mm

Height
360/450/720/900mm

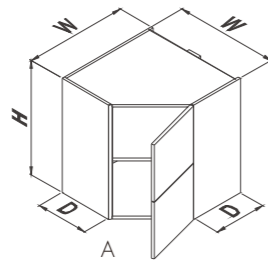

Code
WA13

Description

Corner wall unit, 1 pinned door, 1 shelf, standard cabinet size: door thickness < 22, W=633, D=330, door thickness=22, W=637, D=330, door panel width is 400mm

Width 633/637mm
Depth 330mm

Height
720/900mm

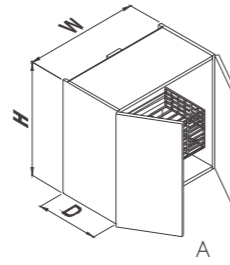

Code
WE03

Description

2 doors, 1 tandem pull-out OP-LK060/070/080/090A

Width
600/700/800/900mm

Depth
330mm

Height
720/900mm

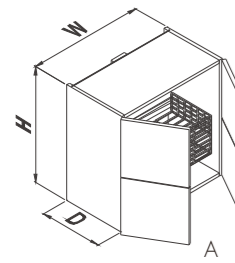
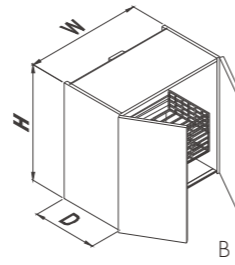

Code
WE04

Description

2 pinned doors, 1 tandem pull-out OP-LK060/070/080/090A

Width
800/900mm

Depth
330mm

Height
720/900mm

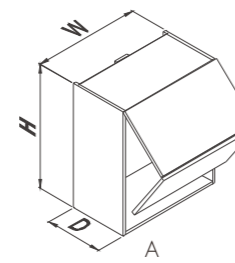
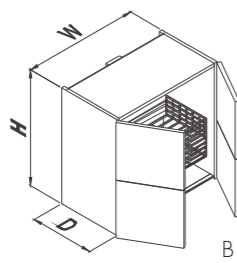

Code
WE05

Description

1 folding door, 1 fitting, 1 tandem pull-out OP-LK060/070/080/090A

Width
600/700/800/900mm

Depth
330mm

Height
720/900mm

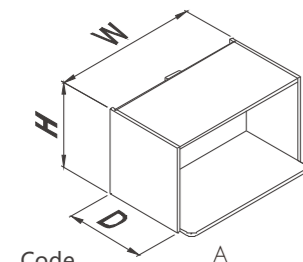
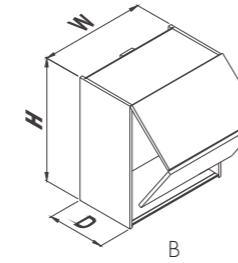

Code
WK04

Description

Open wall unit, standard cabinet height: H=360mm, standard cabinet depth: D=330mm, standard cabinet width: W=600mm

Width
600mm

Depth
330mm

Height
360mm

Wall Cabinet(metric)

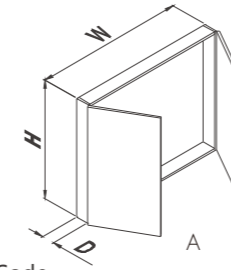

Code
WB09

Description

Range hood filler, 2 doors, no back panel

Width
900mm

Depth
80mm

Height
640/660/720/820/840/900mm

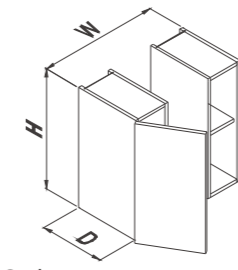

Code
WB10

Description

Range hood wall unit, 2 doors, 1 fixed shelf

Width
900mm

Depth
330mm

Height
640/660/720/820/840/900mm

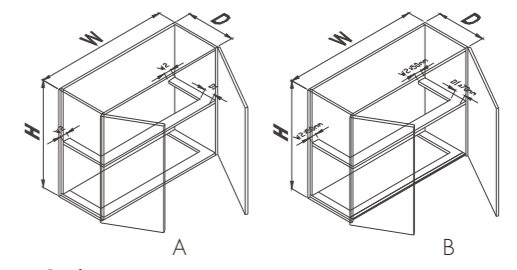

Code
WB11

Description

Range hood wall unit, 2 doors, 1 fixed shelf, 1 U-shape pipeline, D1≥40mm, W2≥50mm

Width
900mm

Depth
330mm

Height
720/900mm

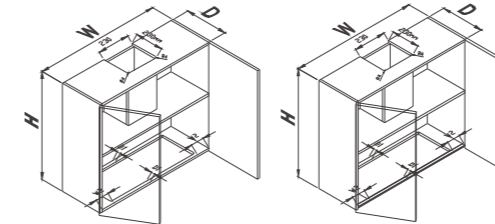

Code
WB12

Description

2 doors, 1 fixed shelf, 1 U-shape pipeline, D1≥40mm, W2≥50mm, gap dimension: 230*230mm

Width
900mm

Depth
330mm

Height
720/900mm

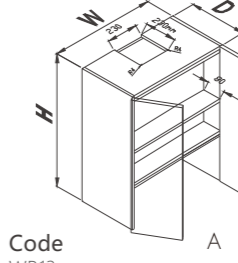

Code
WB13

Description

Range hood wall unit, 2 doors, 1 fixed shelf, width: 80mm, gap dimension: 230*230mm

Width
900mm

Depth
330mm

Height
720/900mm

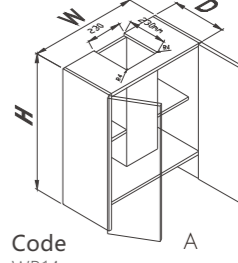

Code
WB14

Description

Range hood wall unit, 2 doors, 2 fixed shelves, 1 U-shape pipeline, gap dimension: 230*230mm

Width
900mm

Depth
330mm

Height
720/900mm

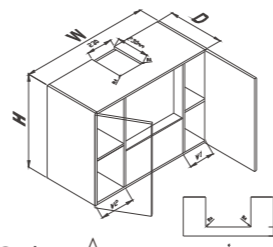

Code
WB15

Description

Range hood wall unit, 2 doors, 2 movable shelves, 3 fixed fillers, 2 subpanels, depth: 80mm, D1≥40mm, W1/W2≥150mm, gap dimension: 230*230mm

Width 1000mm
Depth 330mm

Height
720/900mm

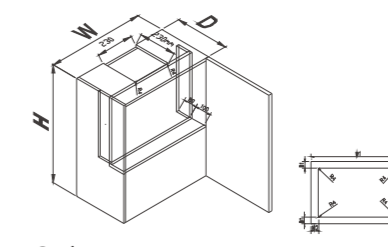

Code
WB16

Description

Range hood wall unit, 2 doors, 2 movable shelves, 3 fixed fillers, 2 subpanels, depth: 80mm, D1≥40mm, W1/W2≥150mm, gap dimension: 230*230mm

Width 600mm
Depth 330mm

Height
720/900mm



On-Worktop Cabinet(metric)

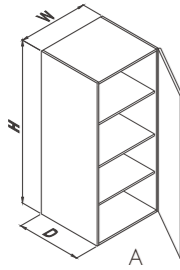

Code
WT13

Description
1 door, 3 shelves

Width
450/600mm

Depth
330mm

Height
1380/1560mm

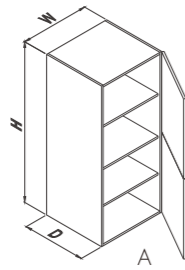

Code
WT14

Description
1 pinned door, 3 shelves

Width
450/600mm

Depth
330mm

Height
1380/1560mm

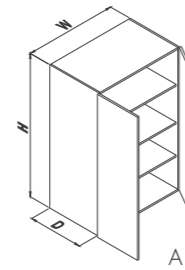

Code
WT15

Description
2 doors, 3 shelves

Width
600/900mm

Depth
330mm

Height
1380/1560mm

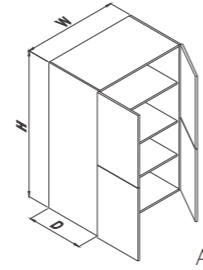

Code
WT16

Description
2 pinned doors, 3 shelves

Width
600/900mm

Depth
330mm

Height
1380/1560mm

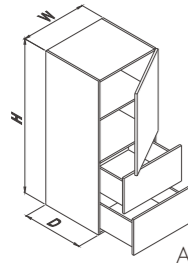

Code
WT17

Description
1 door, 2 drawers, 1 shelf

Width
600/900mm

Depth
330mm

Height
1380/1560mm

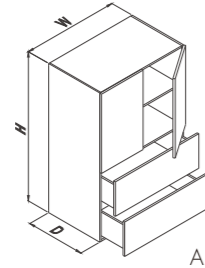

Code
WT18

Description
2 doors, 2 drawers, 1 shelf

Width
600/900mm

Depth
330mm

Height
1380/1560mm

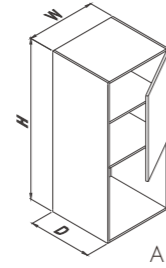

Code
WT19

Description
1 door, open cabinet

Width
600mm

Depth
330mm

Height
1380/1560mm

Refrigerator Top Cabinet(metric)

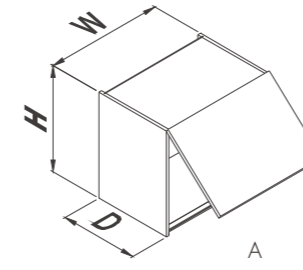

Code
WD10

Description
Lift-up door, height: H=450, depth: D=330mm,
over 900mm needs vertical plate

Width
600/900/1000mm

Depth
330mm

Height
450/500/550mm

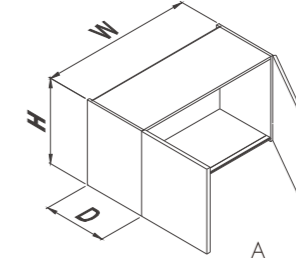

Code
WD11

Description
2 doors, height: H=450, depth: D =330mm,
over 900mm needs vertical plate

Width
600/900/1000mm

Depth
330mm

Height
450/500/550mm

Open Cabinet (metric)

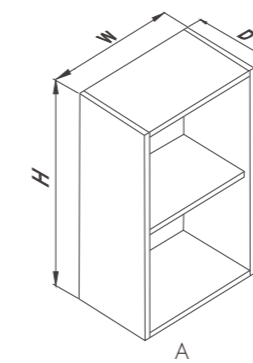

Code
BK06

Description
Open wall cabinet, optional door,
panel/carcase height: H=720, depth: D =330mm

Width
150/200/300/350/400/450/500/600/
700/800/900/1000/1200mm

Depth
80/330/350/560/600mm

Height
330/360/450/660/720/762/900/1380/
1440/1560/2100/2160/2280/2370mm

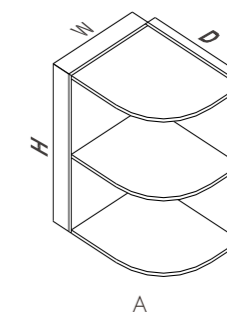

Code
BY03

Description
Open cabinet, R 300 arch cabinet, optional door,
panel/carcase height: H=720, depth: D =330mm

Width
300mm

Depth
330/350/560/600mm

Height
660/720/762/900/1380/1440/
1560/2100/2160/2280/2340mm

